



## Instruction Manual

Wright Manufacturing  
4600X Wedgewood Blvd  
Frederick, Md 21703

Stander Intensity serial # 69788 and higher



### **WARNING: READ THIS MANUAL BEFORE USING**

For your safety and for proper operation and maintenance read carefully and keep readily available for future reference.

10/2014

## Foreword

Welcome to the progressive group of mowing professionals who use Wright mowers. We are focused on giving you advanced engineering and quality construction in each mower we build.

This manual explains the features and promotes safer use of the mower. Please read it in its entirety and follow the instructions carefully so that you can have many years of safe and productive operation with your Wright product. *This manual contains information pertaining to European models also. All information referencing "CE" only applies to European units.*

For service, remember that your Wright dealer knows your mower best and is interested in your satisfaction. Your dealer can provide you with quality maintenance and other assistance that you may need.

Please provide this manual to anyone who may operate the mower for them to study before operation. Additionally, make the manual and service documents available to anyone to whom you may sell the mower in the future. It is important that the next owner receive this information also.

As Wright Manufacturing, Inc. is constantly seeking ways to improve its products, the mower you have may differ slightly from the information and specifications in this manual. Wright reserves the option to make changes at any time without notice, in the process of continually improving our products.

Wright Manufacturing, Inc.



### SAFETY ALERT

**This is the safety alert symbol. It is used throughout this manual and on the mower's safety labels to alert you to potential personal injury hazards. Obey all safety messages that follow this symbol to avoid possible injury or death. Read these instructions carefully. It is essential that you read the instructions and safety precautions before you attempt to work on or use this unit.**



### WARNING

**This symbol with the "WARNING" indicates a potentially hazardous situation which, if not avoided, could result in death or serious injury.**



### CAUTION

**This symbol with the word "CAUTION" indicates a potentially hazardous situation which, if not avoided, may result in minor or moderate injury.**

©1998-2014 Wright Manufacturing, Inc. All rights reserved. This material may not be reproduced or copied, in whole or part, without written permission from Wright Manufacturing, Inc. Grass Gobbler, Gobbler, Leaf Gobbler, Velke, Pro 1, X2, Stander, and Sentar are trademarks of Wright Manufacturing, Inc.

# TABLE OF CONTENTS

<b>PRE-DELIVERY SERVICE OF MOWER BY DEALER</b> .....	<b>5</b>
1 INTRODUCTION.....	7
1.1 TECHNICAL DATA.....	7
1.2 GENERAL SAFETY INSTRUCTIONS.....	8
1.2.1 DO'S AND DON'TS.....	8
1.2.2 WARNINGS.....	8
1.3 IMPORTANT INFORMATION.....	8
1.4 OWNER/USER NOTICE.....	9
1.5 SAFETY FOR OPERATION.....	9
1.6 USER QUALIFICATIONS.....	9
1.7 USER CLOTHING.....	9
1.8 INSPECT MOWER BEFORE EACH USE.....	9
1.9 REGULAR MOWER SAFETY.....	10
1.10 PREVENT FIRES.....	10
1.11 WORK AREA CONDITIONS & INSPECTION.....	10
1.12 INITIAL OPERATING SAFETY GUIDELINES.....	10
1.13 SAFETY FOR MAINTENANCE.....	11
1.14 OPERATION IN FORWARD DIRECTION.....	11
1.15 OPERATION IN REVERSE.....	12
1.16 ZERO-RADIUS TURN OPERATION.....	12
1.17 OPERATION ON SLOPES.....	12
1.18 FUEL SAFETY.....	13
1.19 USING A SPARK ARRESTER.....	13
1.20 RESPONSIBLY HANDLING WASTE PRODUCT AND CHEMICALS.....	13
1.21 HYDRAULIC SAFETY.....	13
1.22 REPLACEMENT PARTS.....	13
<b>2 WARNINGS, SAFETY AND INSTRUCTIONAL DECALS</b> .....	<b>14</b>
<b>3 SPECIFICATIONS</b> .....	<b>15</b>
<b>4 MACHINE DESCRIPTION &amp; OVERVIEW</b> .....	<b>17</b>
4.1 OPERATOR'S AREA.....	18
4.2 MODEL AND SERIAL LOCATION.....	18
4.3 CONTROL PANEL & STEERING CONTROL LEVERS.....	19
4.4 DIGITAL HOUR METER.....	19
4.5 FUEL SYSTEM / SHUT-OFF VALVE.....	19
4.6 DECK LIFT LEVER.....	20
4.7 SAFETY INTERLOCK SYSTEM.....	20
<b>5 OPERATING INSTRUCTIONS</b> .....	<b>21</b>
5.1 INSPECTION OF MOWER BEFORE EACH USE.....	21
5.2 HOW TO START THE MOWER.....	21
5.3 HOW TO DRIVE THE MOWER.....	21
5.4 HOW TO STOP AND PARK THE MOWER.....	22
5.5 DRIVING THE MOWER OVER A CURB.....	22
5.5.1 NEVER DRIVE STRAIGHT ONTO OR OFF A CURB.....	23
5.6 MOWING ON VARYING TERRAIN.....	23
5.7 HOW TO ADJUST NEUTRAL.....	23
5.8 HOW TO PERFORM THE TRACKING ADJUSTMENT.....	23
5.9 HOW TO TEST/USE THE BLADE CLUTCH/BRAKE SWITCH.....	24
5.10 HOW TO TEST THE OPERATOR PRESENCE CONTROL (OPC) SWITCH.....	24
<b>6 SERVICE AND ADJUSTMENTS</b> .....	<b>24</b>
6.1 TIRE MAINTENANCE AND PRESSURE.....	24
6.2 HEIGHT OF CUT.....	25
6.2.1 DECK LIFT SPRING ADJUSTMENT.....	25
6.2.2 DECK ADJUSTMENTS.....	25
6.3 BELT TENSION ADJUSTMENT.....	26
6.3.1 REPLACING THE DRIVE BELT.....	26
6.3.2 REPLACING THE CUTTER DECK BELT(S).....	26
6.4 HOW TO MOVE THE MOWER IF THE ENGINE WONT START.....	27

6.5 HYDRAULIC SYSTEM ..... 27

6.6 HYDRO OIL TANK CHECK / FILL..... 27

6.7 BLEEDING AIR FROM THE HYDRAULIC SYSTEM..... 27

6.8 BATTERY SERVICE..... 28

6.9 PARKING BRAKE ADJUSTMENT ..... 28

6.10 LUBRICATION..... 28

6.11 CUTTING BLADES ..... 28

6.12 FUEL EVAPORATION SYSTEM ..... 29

6.13 SPINDLE & DRIVE PULLEY SPLIT HUB R&R..... 29

6.14 LOADING AND UNLOADING ..... 30

6.15 TRANSPORTING ..... 30

6.16 CLEANING THE MOWER..... 30

6.17 KAWASAKI ENGINE MANUAL/MAINTENANCE ..... 30

**7 ELECTRICAL SCHEMATIC ..... 31**

**8 DECALS..... 32**

**9 MAINTENANCE INTERVAL CHART ..... 33**

**MAINTENANCE RECORD ..... 34**

**POWER EQUIPMENT LIMITED WARRANTY ..... 35**

**FEDERAL & CALIFORNIA EMISSION CONTROL WARRANTY STATEMENT ..... 36**

**CUT QUALITY AND MOWING TIPS..... 38**

# Pre-Delivery Service of Mower by Dealer



**If you are not completely familiar with the Safety Instruction Manual read it now before proceeding with the Pre-Delivery Service of the mower. Only your authorized Wright dealer should perform the Pre-Delivery Service of the mower.**

The Wright Stander Intensity is shipped completely assembled and has been adjusted and tested at the factory. However, due to jostling during the shipping process and the delivery time lapse the following items need to be repeated again before starting the mower. After you have uncrated the mower, follow these procedures in the order indicated:

- Inspect the mower for any damage, unusual conditions or missing parts.
- Inspect the mower for all of its decals, especially the warning decals. There should be one blade warning decal on each side of the deck, the “shield missing” under the blade belt covers, and the dash decal.
- Check service, parts and recall bulletins to ensure unit does not need any updates.
- Check (and fill if necessary) engine oil level according to the engine manufacturer’s recommendation.
- Check (and fill if necessary) hydraulic fluid level. Use fully SYNTHETIC oil: Mobil-1 15W-50 (see Hydro Check/Fill section of this manual).
- Check rear tire pressure – 18 – 22 psi. is recommended. Use the higher pressures for heavier operators. Front Casters are equipped with non-pneumatic tires and do not require any air. *Lowering tire pressure will affect deck pitch. **Always check pitch any time tire pressure is set below recommended pressures.***
- Check the battery to see that the cables are tight and connected properly. The battery is 12 volts and is a maintenance-free battery. Only charge the battery if it will not start the mower properly.
- Check the Rapid-Hite deck height adjustment mechanism for proper operation.
- Lubricate all moving parts (see Maintenance Items section of this manual).
- Add regular unleaded gasoline to fuel tank. (use a minimum of 87 octane gasoline) (*You may use gasoline containing up to 10% ethanol and gasoline containing up to 5% of methanol.*)
- Check brake safety interlock.
  - Try starting the engine with the parking brake released. (Engine should not start. If engine starts, service the parking brake locking system)
  - With the hand controls in the middle or neutral position, apply the parking brake.
- Start the engine according to the engine manufacturer’s recommendation. Let the engine run at low - mid RPM for several minutes to ensure the engine oil reaches all of the engine parts and gets the hydraulic fluid circulating through the pumps, etc.
  - Check if the parking brake locking system prevents the units from being driven while engaged. If not, service the parking brake locking system.
- Release the parking brake. Next, move the hand control levers, one at a time, to make the wheels move in forward and backward rotation.
- Before testing the blade clutch/brake operation, make sure the area is clear and there is nothing vulnerable to possible thrown objects from under the mower. No one should be near the mower deck or in its line of discharge at this or at any time. The discharge chute deflector should be in the down position.

- Move the engine throttle control to  $\frac{3}{4}$  RPM speed setting.
- Turn on the blade clutch switch. Run blades for approximately one minute. Next, engage and disengage the blades a few times about 10 seconds apart. If the blades do not start and stop in a few seconds each time, service the blade brake system.
- With the blades on, disengage the OPC switch to test the Operator Presence Control switch (OPC). A time delay has been added to the OPC system. The engine should die and the blades should stop with-in 6-9 seconds after stepping off of the foot platform. If not, service the OPC system.
- Disengage the blades.
- Drive the mower around on a level parking lot. Check that the mower drives in a straight line when both hand controls are at the full speed position. (If not, refer to How to Perform The Tracking Adjustment section of this manual) (The control handles may not line up perfectly)
  - As you drive the mower, listen for any unusual noises and test for irregular operation and adjust or service as necessary.
- *Go over the safety information and operating procedures in this manual with the customer. Instruct each customer in proper operation and observe the customer during their initial operation on a level parking lot. Repeat until the customer is familiar and comfortable with the basic operation and use of the mower.*
- **Dealer:**
  - **Register the mower online within 14 days from the date of retail purchase. (If unable to use the online registration process, contact your Distributor to register for you)**
  - **Registering the product indicates you have successfully completed the pre-delivery service checklist.**
  - **The limited warranty is considered invalid unless the unit is registered and the above steps are taken.**
  - **Remember, the purchaser is both your customer and our customer and his/her satisfaction is very important. Thank you for supporting our products.**

*The mower is now ready for delivery to your customer*

# 1 Introduction

This mower is built to the highest standards in the industry. However, carelessness or operator error may result in serious bodily injury or death. Accident and hazard prevention are dependent upon the awareness, concern, wisdom, and proper training of the personnel involved in the operation, transport, maintenance, and storage of the equipment. Make sure every operator is properly trained and thoroughly familiar with all of the information in this manual before operating the equipment.

This machine is constructed only for mowing grass on lawns without obstacles such as stones, tree stumps etc. The machine can also be used for other tasks when equipped with special accessory attachments; Grass Gobbler, Velke Sulky and JRCO attachments. All other types of uses are incorrect. The manufacturer's directions concerning operation, maintenance and repairs must be carefully followed.

Lawn mowers and all power equipment, can be potentially dangerous if used improperly. Safety requires good judgment, careful use in accordance with these instructions and common sense.

The machine must only be operated, maintained and repaired by persons familiar with the machines special characteristics and who are also knowledgeable about the safety instructions. Use only approved repair parts to maintain.

Accident prevention regulations, other general safety regulations, occupational safety rules, and traffic regulations must be followed without fail.

Unauthorized modifications to the design of the machine will absolve the manufacturer from liability for any resulting personal injury or property damage.

## 1.1 Technical Data

Weight of overall machine	36" ( 91 cm) = 726 lbs (329 kg) 48" (122 cm) = 815 lbs (370 kg) 52" (132 cm) = 823 lbs (373 kg)
Machine dimensions	36" (91 cm) = 62" (157.5 cm) L x 36.5" *49.5" (93 cm *126 cm) W
*Chute deflector down	48" (122 cm) = 59.75" (152 cm) L x 49" *62" (124 cm *157.5 cm) W 52" (132 cm) = 59.75" (152 cm) L x 53" *66" (135 cm *168 cm) W
Speeds	Fwd. 8.2 mph (13.2 km h), Rev. 3.5 mph (5.6 km h)
Power supply	12V DC

For service documents go to [www.wrightmfg.com](http://www.wrightmfg.com), select support, then, click service docs tab.



### **WARNING**

#### **CALIFORNIA Proposition 65 Warning**

The engine exhaust from this product contains chemicals known to the state of California to cause cancer, birth defects or other reproductive harm.

## 1.2 General Safety Instructions

The Wright Stander Intensity is designed with your safety in mind. It has the following safety systems with which you should become familiar:

- The warning decals on the mower including the instrument panel warning
- DO NOT disable any of the safety features.
- The blade switch must be “off” before starting the engine
- Your feet must be on the foot platform in order to engage the blades
- If you remove your feet from the foot platform while the blades are running the engine will stop and the blades will brake in seconds
- Letting go of the hand controls will stop the wheels instantly
- Spring loaded chute deflector helps reduce trajectory of thrown objects
- Belt/pulley covers on cutter deck
- Anti-tip rollers provided at the rear of the mower reduce the risk of mower tipping.

### 1.2.1 Do’s and Don’ts

Do's	Don'ts
Read the operators manual before attempting to operate this machine	Don't disable safety switches
Use all PPE's, eye protection, ear protection and safety shoes	Don't operate when lightening is seen
Ensure all safety switches are operational	Don't lift with a forklift
Keep all shields and covers in place	Don't change RPMs outside of operating limits
Clean flammable material from machine	Don't tow or push
Inspect fuel system and fuel lines for cracks, leaks and dryrott	Don't operate on slopes when wet
Inspect area to be mowed for hazards	Don't leave a running machine unattended
Only operate in daylight	Don't change the engines governor setting or overspeed the engine
Mow safe distances away from drop-offs and other hazards	Don't operate the machine wearing sandals, sneakers or any loose fitting clothes
Maintain a safe distance from people and pets	Don't back up without being aware of what is behind the machine
Follow daily and weekly maintenance checklists	Don't suddenly push in forward direction while machine is in a rearward motion
Observe traffic laws while driving machine from one location to another	Don't operate a poorly maintain machine
Thoroughly inspect the machine after striking a foreign object	Don't allow persons to operate this machine without reading the operator manuals
Turn off blades when not mowing	Don't put hands or feet under any part of the machine while it is running
Slow down before turning	Don't ever carry passengers
Stop engine before removing Grass Gobbler or cleaning under deck	Don't discharge material towards anyone
Use caution when loading or unloading the machine onto a truck or trailer	Don't operate the machine if you are sick, fatigued or under the influence of alcohol or drugs

### 1.2.2 Warnings!

These warnings are provided to improve safety and should be carefully read before using or maintaining the machine.



**WARNING**

This symbol with the word “WARNING” indicates a potentially hazardous situation which, if not avoided, could result in death or serious injury.



**CAUTION**

This symbol with the word “CAUTION” indicates a potentially hazardous situation which, if not avoided, could result in minor or moderate injury.

## 1.3 Important Information

It is vital that these instructions are available to machine users. It is also important to retain with the machine if the machine is sold or transferred to another user.



## 1.4 Owner/User Notice



The owner's/user's obligation is to instruct themselves and all potential users in the safe operation of this equipment and be sure they read and follow the instructions in this safety manual and other material provided by Wright Manufacturing, Inc. before using or allowing others to operate the equipment. Do not operate this unit unless you carefully read, understand and follow the assembly, installation, and safety instructions contained in this manual and the warning decals provided on the unit. Do not allow other persons to use this unit unless you make sure they carefully read, understand and follow these instructions. Never allow children to operate or play on the unit.

## 1.5 Safety for Operation



The Wright Stander Intensity should only be used by fully trained operators to prevent the risk of injury to themselves or other personnel. The owner's/user's obligation is to instruct themselves and all potential users in the safe operation of this equipment and be sure they read and follow the instructions in this safety manual and other material provided by Wright Manufacturing, Inc. before using or allowing others to operate the equipment. **DO NOT** operate this unit unless you carefully read, understand and follow the operation and safety instructions contained in this manual and the warning decals provided on the unit. **DO NOT** allow other persons to use this unit unless you make sure they carefully read, understand and follow these instructions. Never allow children to operate or play on the unit.

## 1.6 User Qualifications



This product is designed for use by physically fit, experienced, professional commercial mower operators who have a minimum of 160 hours of experience operating twelve horsepower and greater industrial mowers. Operators must be 18 years or older and weigh at least 120 pounds and no more than 325 pounds. They must have read and understood this manual. **DO NOT** allow children to operate the mower. Never allow passengers on the mower. **DO NOT** allow adults to operate the mower without proper instruction mentioned above.

## 1.7 User Clothing



**DO NOT** operate the mower while wearing sandals, tennis shoes, sneakers, or shorts. Always wear long non-baggy pants. Wear high-top leather steel-toed work boots with thick, textured tread, soft-rubber soled at all times. Hard or smooth soled shoes are too slippery for a good footing on mower platform. **NEVER** wear loose-fitting clothing or jacket pockets that can get caught on the handlebars or control levers of any mower you drive. Wearing safety glasses, ear protection and safety shoes is advisable and required by some local ordinances and insurance regulations.

## 1.8 Inspect Mower Before Each Use



**DO NOT** use the mower if any parts are not maintained in good operating condition. Examine the moving parts prior to each use. Look for excessive wear, bald or worn tires, cracks in parts, loose or missing bolts, cotter pins, linchpins or "hair" pins or cable yoke pins and replace before operating the mower. Make sure all safety equipment provided with the mower is in good operating order, including all the warning decals and the required operator-presence device which stops the engine and blades when the foot-operated Operator Presence Control (OPC) switch is released. (To test the OPC, follow instructions in the [Operating Instructions](#) section of this manual.) Inspect the two anti-tip rollers and their respective bolts at the rear of the mower for tightness and proper operation. Be sure that all parts of the hand-operated hydraulic control system are tight and secure. This is to reduce the possibility that the mower could have a loss of control.

## 1.9 Regular Mower Safety

Keep your Wright mower in good operating condition, and keep safety devices and shields in place and in working condition. Replace worn tire(s) with less than 3/32" of any tread groove left. Use tires with the tread pattern specified by Wright Mfg., Inc. only. DO NOT change the engine governor settings or over-rev the engine contrary to engine manufacturer specifications. Failure to comply can compromise operator safety, shorten equipment life and void your manufacturer's warranty. Keep all nuts, bolts, and screws tight to be sure the equipment is in safe working condition. Check the blade mounting bolts for proper tightness every eight (8) hours of operation. Check the blades for excessive wear and sharpness every four to eight (4-8) hours of operation. Sharpen dull blades. Replace blades when they become excessively worn. The mower should not be used after the blades or other part of the mower strikes a foreign object, until conducting a thorough inspection and any damage is repaired. *When inspecting or changing blades, turn off the blade clutch switch, apply the parking brake, stop the engine and remove the key.* Make sure the chute deflector is always in place and operating properly. Replace if the deflector becomes worn or ceases to properly deflect the grass in a safe manner. (Refer to the maintenance interval chart at the end of this manual)

## 1.10 Prevent Fires



Machine fires and structural fires can occur if a machine is stored before allowing it to cool, if debris is not removed from critical areas of the machine, or if the machine is stored near combustible materials.

- Remove grass and debris completely from engine compartment and muffler area, and from on top of the mower deck, before and after operating machine, especially after mowing or mulching in dry conditions.
- Always shut off fuel when storing or transporting.
- Do not store near an open flame or source of ignition, such as a water heater or furnace.
- Check fuel lines, tank, cap and fittings frequently for cracks or leaks. Replace immediately if necessary.

## 1.11 Work Area Conditions & Inspection



Prior to operating the unit, carefully inspect all lawn/ground areas where you plan to use the mower for hidden, hard-to-see objects or uneven ground that may be hidden in the grass. Clear the work area of moveable objects such as wires, rocks, glass, toys, etc. that might be picked up by the mower and dangerously thrown. Remove, if possible, or mark the location of all immovable objects or irregular areas and be sure not to hit them with any part of the mower, its deck or the blades. Obstacles such as holes, abrupt changes in ground contour, tree trunks, stumps or roots, pipes protruding from the ground, paving edges, etc. in the path of operation can abruptly turn or stop the mower. This could throw you off the mower or into and possibly over the handle bars causing serious injury or death. The faster you are moving the more potential there is for injury. Mow only in daylight or in good artificial light. Keep away from drop-offs, the edges of ponds, streams, pools, etc. especially at the bottom of slopes. Do not mow when children or others are around. When the Wright mower is in use, never direct the grass discharge toward bystanders, traffic, cars or buildings nor allow anyone within 50 feet of the machine while in operation. Thrown objects can pass through glass windows and some walls of buildings. There is extreme risk of danger from thrown objects or being cut by the blades of the mower or being run over if you lose control. Never operate the mower in an enclosed area without good, approved ventilation. Exhaust fumes are dangerous.

## 1.12 Initial Operating Safety Guidelines



- Read and understand the warnings on the instrument panel of the mower.
- Regularly check and test the safety devices for correct function.
- Recommended PPE is safety shoes, safety glasses and ear protection.
- Keep a firm hold on the stationary handle at all times.
- Keep both feet on the foot platform at all times.
- Know the controls and how to stop quickly.

- Before attempting to start the engine, follow all starting instructions below and in the engine operator's manual.
- Look behind before backing up.
- Before leaving the operator's position, even momentarily, turn off the blade clutch engagement switch and apply the parking brake. Keep others from coming near the mower. Get back on the mower as soon as possible.
- When leaving the Wright mower unattended, turn off the blade clutch engagement switch, apply the parking brake, stop the engine and remove the key. **Never** leave the machine unattended on a slope in case someone disengages the parking brake. This could create a rollover hazard.
- When transporting, driving onto transport vehicles, into buildings, across parking lots or otherwise not mowing grass, turn off the blade clutch engagement switch to reduce risk of thrown objects and rotating blade hazard. After coming to a stop apply the parking brake, stop the engine and remove the key.
- Before performing any maintenance or repair service, disengage power to blades, apply the parking brake, stop the engine, remove ignition key and spark plug wire from spark plug(s).
- All operators of this mower should exercise caution when driving this mower at high speeds. Sudden acceleration or deceleration may cause serious injury.
- **Do not** allow inexperienced persons to operate the mower until they have read and understood these safety instructions. Operate the mower at slower speeds while becoming familiar with it.
- The grass discharge chute deflector must be installed at all times and in the down position except that it may be raised when cleaning out the deck or a grass catcher is installed or a mulch kit and block-off plate is properly installed.
- If the mower discharges grass clogs, turn off the blade clutch switch, apply the parking brake, stop the engine and remove the key before removing obstruction(s).
- Keep all shields and covers in place, namely, all blade and belt covers, engine shields, and grass discharge chute deflector.
- Keep hands, feet and clothing away from rotating parts, especially the rear wheels, blades, engine flywheel, belts and pulleys.
- **Do not** touch engine, muffler or hydraulic system while engine is running or soon after it is stopped. These areas can be so hot as to cause severe burns.
- **Clean grass, leaves and lubricant spills from surfaces after use to prevent fire hazard.**
- Be alert for traffic when crossing roads or operating near roadways.
- Before climbing curbs, crossing gravel drives, sidewalks or roads, turn off the blades and wait for them to stop.

## 1.13 Safety for Maintenance



- Repairs carried out by untrained or unauthorized personnel may result in personal injury or serious malfunction of the Stander Intensity.
- If Guarding is removed for inspection and component replacement, ensure the parking brake is applied and key is removed prior to inspecting or making repairs and that the guarding is replaced before operation.

## 1.14 Operation in Forward Direction



Always keep a firm grip on the mower stationary handlebar with both hands. Operate the mower slowly until you become familiar with how the mower operates. Do not operate the mower faster than conditions allow. For example, hills, wet or bumpy ground, dim light or high grass are all conditions requiring slower speeds. Never operate the mower at the highest speed unless you are on level, wide, open areas of clearly visible ground or transporting on paved areas. Speeding with any mower is dangerous, and so is traveling faster than conditions should permit on this mower. Sudden stops from excessive speed or falling off the mower may cause serious injury or death.

## 1.15 Operation in Reverse



Always keep a firm grip on the mower stationary handlebar with both hands. Keep both feet firmly on the foot platform. Look behind you before backing to prevent injuring yourself or anyone behind you. Operate the mower very slowly, inching it backward until you become familiar with how the mower operates. Always operate slowly if in an awkward location or position. While backing up never place your foot or feet on the ground near the back edge of the mower to prevent serious personal injury if the mower were to run over you.

## 1.16 Zero-Radius Turn Operation



During zero-radius turns (when one mower wheel rotates backwards while the other rotates forward) drive extra slowly to reduce the possibility of losing traction, or control, or becoming dizzy. This will help prevent you from being thrown off the mower. Be aware that if you do a turn on a slope you may go through all of the orientations to a slope mentioned below and must handle the mower accordingly.

## 1.17 Operation on Slopes



DO NOT operate on steep slopes. Do not operate the mower on slopes steeper than you can feel secure about the traction of the tires and the stability of the mower. Do not operate the mower on slopes at all when the grass is wet. There is a danger of suddenly sliding sideways or down the hill. When operating on a slope, travel across the grade whenever possible, not in an up or down pattern. Reduce speed and exercise extreme caution on slopes and in sharp turns to prevent tipping or loss of control. Be especially cautious when changing direction on slopes.

**When pointing up a slope**, your mower has the most weight on the drive wheels and therefore the most traction at the tires. However, this is the angle that it has the most tendency to tip back (“pop a wheelie.”) This is the preferred angle for mowing small areas of steeper slopes.

### Recommendations for this angle:

- Lean as far forward as possible to add your weight to the front of the mower.
- Accelerate gently. Do not accelerate quickly to avoid “popping a wheelie”.
- If backing down the hill, do not stop suddenly but slow down gradually.

**When pointing down a slope**, your mower has the least weight on the rear drive wheels and therefore the least traction at the tires. This is the angle that the mower has the most tendency to slide. However, this is the angle that it has the least tendency to tip back. Avoid this angle, as it has the least advantage for your mower.

### Recommendations for this angle:

- Lean back with arms stretched out straight while holding onto the stationary handlebar. This transfers more of your body weight to the rear drive wheels for more traction.
- Do not change speed suddenly to minimize the tendency of going into a slide. Accelerate and decelerate gently. If you ever go into an uncontrolled slide while pointing down a slope the recommended procedure is to let go of the handles and jump off if necessary. Otherwise, control the mower gently and stay off slopes that tend to make the wheels slide.

**When crossing a slope sideways**, your mower has the average amount of weight on the drive wheels versus the front wheels, similar to level ground. However, this angle leaves the least weight on the higher side drive wheel, tending to make it slip. This is the preferred angle for mowing large areas of gentle slopes.

### Recommendations for this angle:

- Lean back and angle yourself to the higher side. This adds weight to the rear drive wheels and will allow you to mow more quickly across the slope without sliding. These are general guidelines only. The mower function and comfort will vary depending on mowing environment, operator driving style and preference.
- To reduce the chances of “popping-a-wheelie”, do not accelerate quickly.

**Note:** Excessively worn tire tread is dangerous. Replace tire(s) with less than 3/32” of any tread groove left. Use tires with the tread pattern recommended by Wright Mfg., Inc. only. Keep the tire pressure in the drive

tires between 18 and 22 psi. Higher pressures will cause the tires to have less traction which may prevent safe operation.

## 1.18 Fuel Safety



Handle gasoline with care – it is highly flammable. Do not smoke while handling gasoline. Use an approved gasoline container. Never remove the fuel cap or add gasoline to a running or hot engine or an engine that has not been allowed to cool for several minutes after running. Never fill the tank indoors and always clean up spilled gas. NEVER store the equipment with gasoline in the tank inside a building where fumes may reach an open flame or spark. Allow the engine to cool before storing in any enclosure.

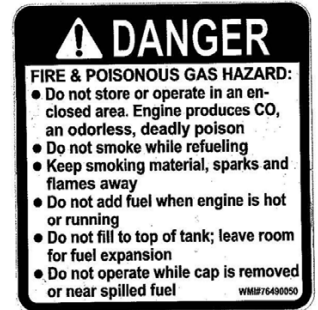

## 1.19 Using a Spark Arrester

The engine in this machine is not equipped with a spark arrester muffler. It is in violation of California Public Resources Code Section 4442 to use or operate the engine on or near any forest-covered, brush-covered, or grass covered land unless the exhaust system is equipped with a spark arrester meeting any applicable local or state laws. Other states or federal area may have similar laws.

## 1.20 Responsibly Handling Waste Product and Chemicals

Waste products, such as used oil, fuel, coolant, brake fluid and batteries, can harm the environment and people:

- Do Not use beverage containers for waste fluids – someone may drink from them.
- See your local Recycling Center or authorized dealer to learn how to recycle or get rid of waste products.

## 1.21 Hydraulic Safety



Keep body and hands away from pin holes or fittings that eject hydraulic fluid under high pressure. Use paper or cardboard and not hands to search for leaks. Hydraulic fluid escape under high pressure may have sufficient force to penetrate skin and cause serious injury. If foreign fluid is injected into the skin, it must be surgically removed within a few hours by a doctor familiar with this form of injury or gangrene may result. Seek medical attention immediately. Make sure all hydraulic fluid connections are tight and all hydraulic hoses and lines are in good condition before starting your Wright mower. Hydraulic fluid is under high pressure. If you need service on your hydraulic system, please see your authorized Wright dealer.

## 1.22 Replacement Parts



Use of parts other than specified parts supplied by Wright Manufacturing, Inc. may compromise the safe use of the mower, are not recommended and their use could void the warranty. Always check with your Dealer or the Wright Mfg. website, [www.wrightmfg.com](http://www.wrightmfg.com) for the Illustrated Parts List for your equipment.

**Wright is fully concerned with your safety. Please read the above repeatedly until you fully understand the methods to promote the safest operation possible.**

For service documents go to [www.wrightmfg.com](http://www.wrightmfg.com), select support, then, click service docs tab.

**REMEMBER – YOUR MOWER CAN BE ONLY AS SAFE AS THE OPERATOR.  
FAILURE TO FOLLOW SAFE OPERATING PRACTICES MAY RESULT IN  
SERIOUS INJURY OR DEATH.**

## 2 Warning, Safety and Instructional Decals

- Specific safety warning decals are located on the equipment near immediate areas of potential hazards.
- Keep all safety signs legible. Remove all grease, dirt and debris from safety signs and instructional decals.
- Replace worn, damaged or missing safety decals.
- If an attachment or accessory has been installed, make sure current safety decals are visible.

- 1 - Choke
- 2 - Throttle, Slow/Idle
- 3 - Throttle, Fast/Full
- 4 - PTO Switch
- 5 - Digital Hr Meter
- 6 - Ignition Switch, Off
- 7 - Ignition Switch, Run
- 8 - Ignition Switch, Start
- 9 - Apply Parking Brake to Start



76490007  
WSTN DASH



76460001  
DECAL, DANGER BLADE  
HAZARD



76490050  
DECAL, FIRE HAZARD  
WARNING



76490089  
DECAL, Danger Label - Fuel  
WARNING













76490001  
DECAL, SHIELD MISSING



76490088  
DECAL, Warning Label - Fuel  
WARNING

	Warning, rotating blades. Keep hands, feet and clothing away from rotating blades. Use safety glasses to avoid thrown material. To inspect blades or clean under side of cutter deck, apply parking brake and remove ignition key.
	Warning, crush hazard. Be aware of your surroundings at all times. Always stop the machine if someone enters the area.
	Warning, shield missing, DO NOT operate with shields missing. Keep shields and covers in place.

	Warning, denotes potential hazardous situation which, if not avoided, could result in minor to serious injury or death
	Caution, rotating pulleys and belts. Keep shields and covers in place while machine is in operation. Keep hands feet and clothing away from rotating pulleys and belts.
	Caution, Battery hazard. Avoid skin contact with battery acid. Do not allow open flame near the battery when charging. Always wear eye protection when checking the battery.
	Caution, hot surface! Avoid skin contact with hot surface
	Warning, potential fire, clean flammable material away from machine. Clean engine fins and exhaust heat shield of any debris build up. Inspect fuel lines for wear and replace when worn. Always clean up spilled fuel and oil.
	Caution, hydraulic fluid under pressure, potential skin puncture. Do not check for leaks with mower running.
	Caution, denotes potential hazardous impeller condition when using the rear bagging system, could result in cutting of fingers or hand while machine is in operation. Keep all shields and covers in place.
	Warning, thrown objects. Never operate the mower deck with the chute deflector damaged, altered, removed or in the raised position, except when using a Grass Gobbler, rear collection system or mulching system is being used.
	Warning, rollover. DO NOT operate near drop-offs, retaining walls, drainage ditches, water and other types of hazards to avoid a wheel dropping over the edge or to avoid the ground from breaking away.
	Warning, reduce speed and exercise extreme caution on slopes and on sharp turns to prevent tipping or loss of control

### 3 Specifications

#### Engine

- See your engine owner's manual
- RPM: Full speed 3600 +/- 50 RPM (no load) / Idle: 1550 RPM

#### Electrical System

- Charging System: Internal stator coil
- Battery Type: Maintenance free
- Battery Voltage: 12 Volts
- Fuses: Two, 20 amp blade type

## Fuel System

- Capacity: 5.5 Gal. (20.8 L)
- Type of Fuel: Unleaded regular gasoline, minimum 85 octane. Do not use gasoline containing more than 10% ethanol. Do not mix oil with gasoline.
- Fuel Filter: In line
- Fuel shut off: On, Off located on fuel tank

## Safety Interlock System

- PTO switch must be disengaged, brake engaged and the control handles in the neutral and locked position to start the engine.
- Operator must have feet on the platform to engage the PTO and brake off or engine will stop.

## Drive System:

- Two Hydro Gear 10cc variable displacement piston pumps
- Two Hydro Gear 12cc wheel motors

## Hydro Oil System

- Hydro Oil: fully SYNTHETIC motor oil: Mobil-1 15W-50
- Hydro Filter: Spin-on, 25 micron, no bypass / PN 34490002
- Total Capacity: 3 qts (2.8 L)
- Tank Fill Level: Fill until fluid comes to the center of the sight glass.

<b>Torque Specifications</b>		
<b>Critical Application</b>	<b>Thread Locker</b>	<b>Torque Range ft-lbs / Nm</b>
Wheel motor bolts (Securing motor to support)	Loctite 2760	40-50 / 54-68 Nm
Clutch to engine shaft	Loctite 2760	50-55 / 68-75 Nm
Wheel hub to wheel motor	N/A	138-158 / 187-214 Nm
Wheel lug nuts	N/A	80-90 / 108-122 Nm
Split Hub (Spindle & Drive) (Gr 8)	N/A	13-17 / 18-23 Nm
Blade Bolts	N/A	70-80 / 95-108 Nm
Deck Lift Adj. Hardware	N/A	45 / 61 Nm

<b>36" (91 cm) Stander Intensity</b>	
Width, deflector down	49.5" (126 cm)
Width, deflector up	36.5" (93 cm)
Length	62" (157.5 cm)
Weight	726 lbs (329 kg)

<b>48" (122 cm) Stander Intensity</b>	
Width, deflector down	62" (157.5 cm)
Width, deflector up	49" (124 cm)
Length	59.75" (152 cm)
Weight	815 lbs (370 kg)

<b>52" (132 cm) Stander Intensity</b>	
Width, deflector down	66" (168 cm)
Width, deflector up	53" (135 cm)
Length	59.75" (152 cm)
Weight	823 lbs (373 kg)



## 4 Machine Description & Overview

The Wright Stander Intensity is meant to solely cut, bag or mulch grass. The use for any other purpose is not recommended. Do not disconnect any safety switches or remove any decals.

- |                             |                           |                   |                       |
|-----------------------------|---------------------------|-------------------|-----------------------|
| 1. Flexible Chute Deflector | 2. Drive Tire             | 3. Fuel Tank      | 4. Fuel Cap           |
| 5. Brake Handle             | 6. Stationary Handle Bar  | 7. Control Levers | 8. Deck Lift Handle   |
| 9. Kawasaki Engine          | 10. Muffler & Heat Shield | 11. Caster Tire   | 12. Anti-Scalp Roller |
| 13. Aero-Core Cutter Deck   | 14. Deck Cover            |                   |                       |



## 4.1 Operator's Area

- 1 - Anti-Tip Wheels
- 2 - Brake Handle
- 3 - Deck Lift Handle
- 4 - Dash/Control Panel
- 5 - Fuel Tank
- 6 - Upright Pad
- 7 - Battery Box
- 8 - Foot Platform



## 4.2 Model & Serial Location

- The plate is affixed to the left side frame below the battery stand.
- Stated on the plate will be the model, date of assembly and serial number, these will be needed when ordering parts.



## 4.3 Control Panel & Steering Control Levers

The Stander Intensity speed and direction are controlled by using the control handles. Moving the control handles equal distance forward or backward the machine moves in a straight line. By releasing the control handles during operation, the controls will return to the neutral position and the machine will stop.

- 1 – Left Forward Motion Control Handle
- 2 – Left Reverse Motion Control Handle
- 3 – Right Reverse Motion Control Handle
- 4 – Right Forward Motion Control Handle
- 5 – Stationary Handle Bar
- 6 – Choke
- 7 – Digital Hour Meter
- 8 – Throttle
- 9 – PTO Switch
- 10 – Ignition Switch/Key



## 4.4 Digital Hour Meter

The Stander Intensity is equipped with a digital hour meter. Refer to operating/reset instructions below.

### The programming specified is:

- Default display: Hours
- Press once (TMR1): Timer 1, press for 3 sec to reset
- Press twice (TMR2): Timer 2, press for 3 sec to reset
- Press three times (svc ENG): Will display time remaining until next service point, hold down to reset. The first interval is 8hr, thereafter 100hr. Beginning 5hr before service point the meter will flash “svc ENG, in [remaining hours]” every 5 sec.
- Shut off engine: Will display how many times the engine has started.



## 4.5 Fuel System / Shut-Off Valve

The fuel shut-off valve and fuel gauge is located on top of the fuel tank. The valve should be in the “OFF” position at all times when the mower is not in use. Do Not fill the tank completely. Max fill level is at the base of the fill neck. This will allow for the gas to expand



## 4.6 Deck Lift Lever

The “Quick Cut” height selector has fifteen different settings, ranging from 1.5” – 5.0” and will adjust the cut height in ¼” increments. To operate, insert detent pin (1) in desired cut height hole, grab deck lift handle and press the top button down (2) with thumb and lower to the selected cut height. The deck handle has a locking mechanism when the button is released but it is also recommended to use the detent pin as well.

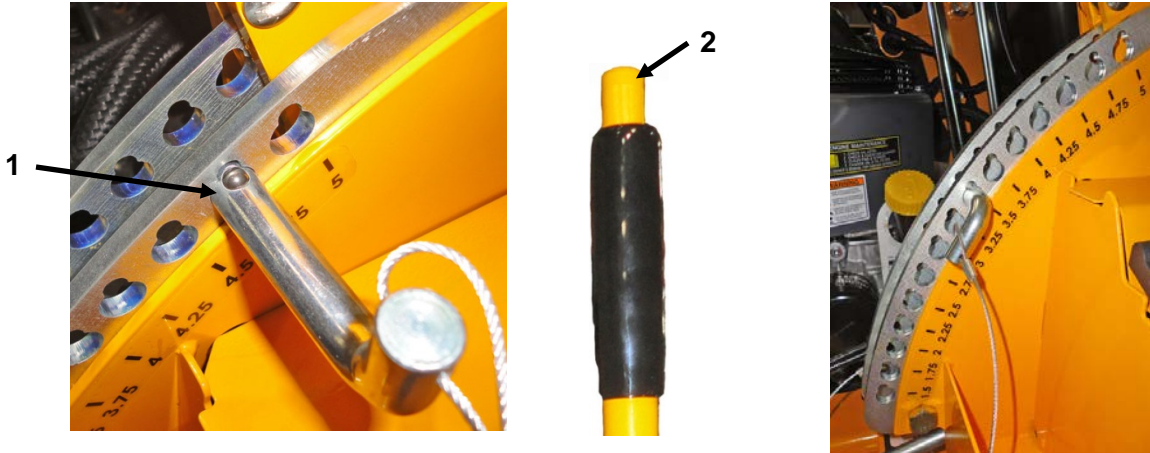

## 4.7 Safety Interlock System

The Wright Stander Intensity is equipped with a safety interlock system. The PTO must be disengaged, brake applied and control levers in the neutral position in order to start the machine. With the brake applied, the controls are locked in the neutral position.

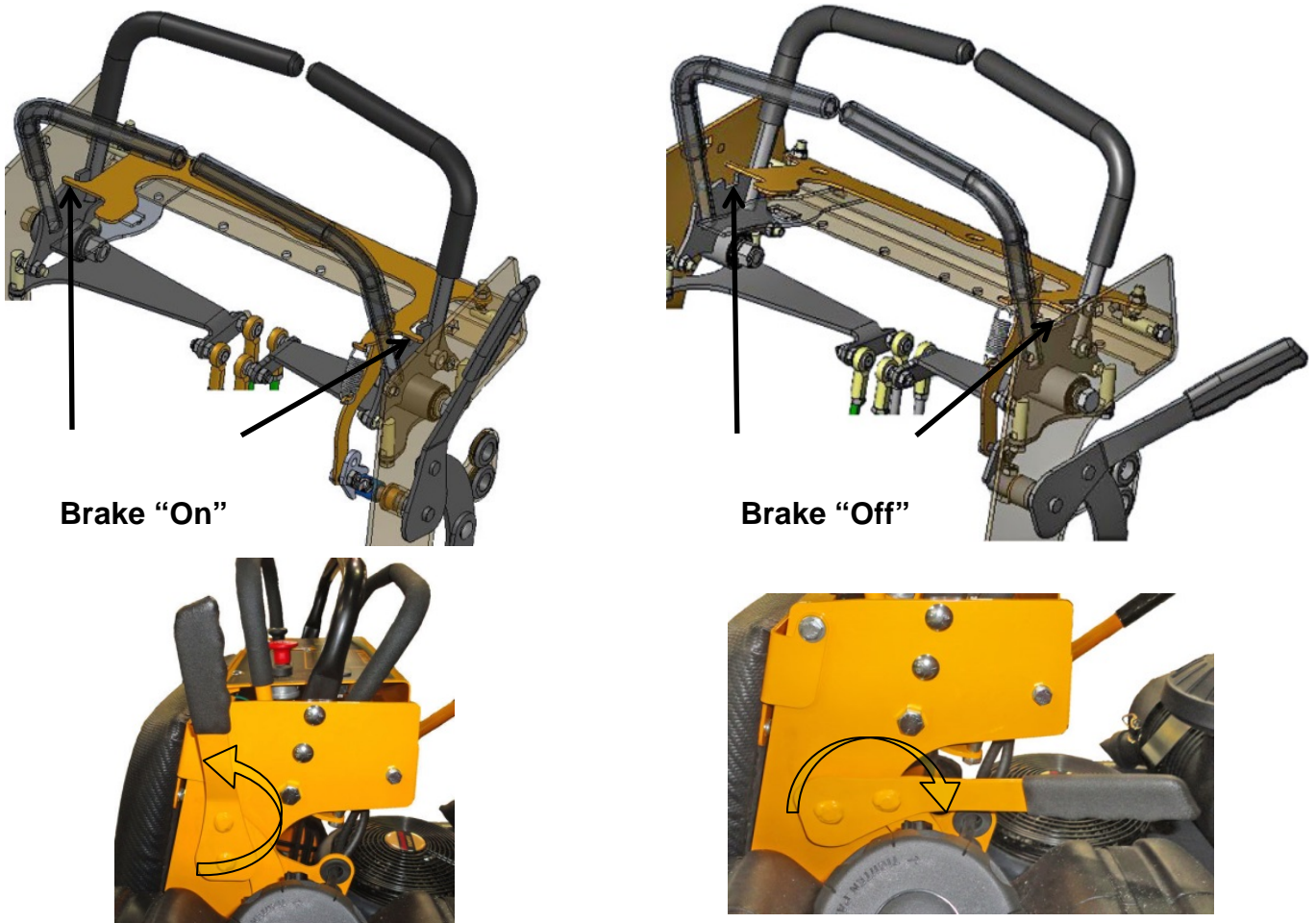

## 5 OPERATING INSTRUCTIONS



If you are not completely familiar with the Safety Instruction Manual read it now before proceeding with the operation of the mower. **REMEMBER THERE ARE CERTAIN PRECAUTIONS LISTED IN THIS MANUAL THAT YOU MUST NOW TAKE BEFORE STARTING THE MOWER.**

### 5.1 Inspect Mower Before Each Use

**Inspection of Mower:** Do not use the mower if any parts are not maintained in good operating condition. Examine all moving parts prior to each use. Look for excessive wear, bald drive tires or worn out front tires (normally smooth), cracks in parts, loose or missing bolts, cotter, linchpin or “hair” pins or cable yoke pins and replace before operating the mower. Make sure all safety equipment provided with the mower is in good operating order, including all warning decals and the operator-presence device which stops the engine and blades when the foot-operated Operator Presence Control (OPC) switch is released. To test the OPC, follow the instructions given later in this manual. Inspect the two anti-tip rollers and their respective bolts at the rear of the mower for tightness and proper operation. Ensure that all parts of the Quad-Lever™ control system are tight and secure. This is to reduce the possibility that the mower could have a loss of control or safety.

**Basic Operation:** The following procedures are to guide you through the basic operation of the mower. You should be a qualified mower operator according to the safety section of this manual. If this is your first time, operation should only be done with the assistance of your dealer on a level area. You should go through each step, in the order indicated, every time you start the mower.

### 5.2 How to start the mower

#### Before starting the engine

- Make sure the control levers are in the exact neutral position
- Apply the parking brake if it is not already set.
- Turn OFF the blade engaging switch if it is on.
- Turn fuel valve to the “ON” position.

#### Starting the engine

##### Electric Start:

- Start the engine according to the engine manufacturer’s recommendation, see engine manual. Set the throttle control lever near mid throttle, pull out on the choke control knob and turn the key to the start position. Do not engage the starter for more than ten (10) seconds at a time. This may overheat the starter and the wiring systems. Wait ten (10) seconds between attempts. If the engine does not start after several attempts or stalls frequently, take the mower in for service.

After starting the engine according to the engine manufacturer’s recommendation, push in on the choke control knob to open the choke valve, let the engine run for several minutes to get the hydraulic fluid circulating through the pumps, etc. and to allow the engine to warm up. Do not over-rev a cold engine.

#### Unusual noises or irregular operation:

As the engine is warming, listen for any unusual noises and test for irregular operation and adjust or service as necessary.



### 5.3 How to drive the mower

While standing, both feet should be firmly placed on the foot platform. Set the engine speed about a fourth of the way from idle. Release the parking brake. Now try moving the hand control levers, one at a time, very slightly, forward and backward. Check to see if the wheels move forward and backward according to the position of the levers. If not, check to see that the pump release valves are closed. With both feet still firmly placed on the foot platform, increase the engine speed to about half of the way from idle speed. Release the parking brake. The higher engine speed will make the controls much more responsive and the mower much

quicker; Use caution if it is your first time. Now try moving the hand control levers, one at a time, very slightly, forward and backward. Gradually increase your speed until you are well acquainted with the operation of the hand controls and the mower's behavior. After gaining a good feel for how the mower handles, gradually attempt higher engine speeds until familiar with operation at full throttle engine speed.

#### **Unusual noises or irregular operation:**

As you drive the mower, listen for any unusual noises and test for irregular operation and adjust or service as necessary

## **5.4 How to Stop and Park the Mower**

Come to a complete stop. If the blades are on, turn them off using the switch on the instrument panel. *Make sure the control levers are in the exact neutral position.* Set the parking brake, reduce the engine speed to idle, shut off the ignition switch to stop the engine and then remove the key from the ignition switch. The mower is now parked. Do not leave mower unattended on a sloped surface.

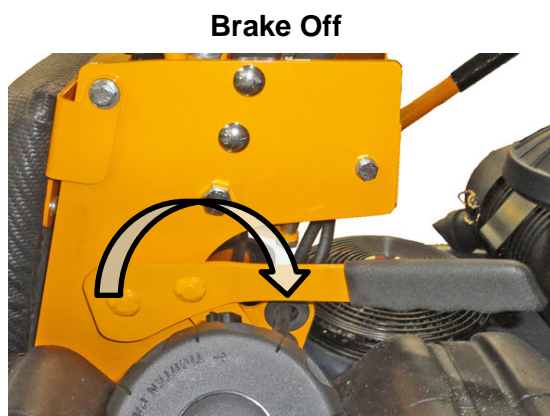

## **5.5 Driving the Mower Over a Curb**



To climb a curb, first see the [Safety Instructions](#) section of this manual, especially the parts on:

- [Initial Operating Safety Guidelines](#)
- [Operation In Reverse](#)
- [Operation In Forward Direction](#)

It is recommended to use ramps for curbs 5" and higher. Using ramps, you can easily back on and off without damaging your mower or the curb.

Curbs 5" and lower, raise the mower deck into the highest position. Then drive the mower in reverse at a 45 degree angle to the curb (with the left side of the mower closest to the curb) until you are within an inch or two of the left-rear tire hitting the curb. Stop and then gradually bump into the curb with that tire until it is just on top of the curb. If the tire slips even while lurching the mower into the curb, then the curb is too high and you should use ramps or find another way. The mower should still be at a 45 degree angle to the curb. Now, while maintaining the same angle to the curb, continue to back up until the right-rear tire is close to the curb. Using the same technique lurch the right tire onto the curb. After both wheels are on top of the curb, turn the mower counterclockwise and back up so the left caster wheel comes over and last should be the right caster wheel as the mower is twisting to the left (counterclockwise). The technique works the best if you try not to drive backwards at a near 90 degree angle to the curb but get all of the wheels to go over while the mower is moving at least a 45 degree angle to the curb. To drive off a curb, first try driving up onto it to make sure the curb is not too high. If the curb is not too high, drive the right-front caster off first while driving toward the curb at a 45 degree angle (the curb should be to your right). Then, maintain that 45 degree angle so the left caster goes over, then the right-rear wheel, then the left rear wheel. Do NOT step off the mower during ANY maneuver.

## 5.5.1 Never Drive Straight Onto or Off a Curb



Never drive straight onto or off a curb. If you do the whole procedure at a very sharp angle it will tend to minimize the contact of the mower deck with the curb and you will be able to more safely control the mower. **It is recommended to use ramps to drive on and off of curbs.** Using ramps, you can easily back on and off without damaging your mower or the curb.

## 5.6 Mowing on Varying Terrain

See the [Safety Instructions](#) section of this manual, especially the parts on:

- [Initial Operating Safety Guidelines](#)
- [Operation On Slopes](#)
- [Operation In Reverse](#)
- [Operation In Forward Direction](#)
- [Operation During Zero-Radius Turns](#)

## 5.7 How to Adjust Neutral

Neutral refers to the mower movement when the engine is set to full throttle, parking brake is off, and the control levers are in the neutral position. The mower should not move forward or backward during this time. If the mower is moving forward or rearward, the neutral setting must be adjusted. The hydraulic pump has a Return-to-Neutral (RTN) device built into the linkage of the pump. Before adjusting neutral, it is necessary to lift the rear drive wheels off the ground using a jack and stands. To make the adjustment, loosen the ¼" Allen bolt **(A)**(this requires a modified ¼" Allen) and rotate the RTN device on the pump corresponding to the wheel that needs adjustment. If the right wheel turns in the neutral position, then the right pump RTN needs to be adjusted. The RTN mechanism should be rotated until the neutral position is found and then retighten the ¼" allen bolt. Use care not to over tighten the allen bolt. Repeat the procedure on the other pump if necessary.

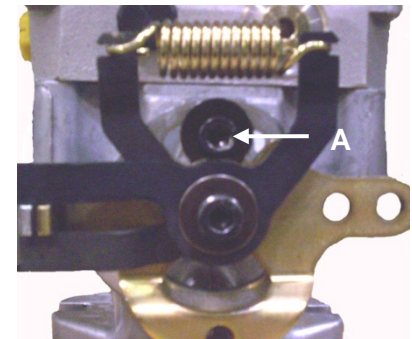

## 5.8 How to Perform the Tracking Adjustment



First ensure that the tire pressure is equal on both rear drive tires. (18-22 psi) Drive the mower on a level parking lot with the engine at full throttle. Check that the mower drives in a straight line when both hand controls are held to the full speed position. If not, park the mower and **stop the engine**. Only adjust the rods connecting directly to the hydraulic pump linkage. The stationary rods are not to be adjusted. The adjustment is made by loosening the jam-nuts on the control rods (this may need to be done to one or both control rods) and adjusting the control rods. Once the jam-nuts are loosened at the top and bottom of the control rod proceed to turning the control rod clockwise or counter-clockwise. Turning the control rod clockwise will shorten the control rod and slow the forward movement of the mower on that side. Turning the control rod counter-clockwise will lengthen the control rod and increase the speed of the forward movement of the mower on that side.

Neither rod should be lengthened so much that at full speed it pulls the pump control lever (on the sides of the pumps) against the internal pump stop. Therefore, to reach the maximum capable speed, the rods should be lengthened one turn at a time until you can feel, in the hand control, that the internal pump stop has been contacted. Then shorten the rod one turn (damage to the hydro pump will occur if the controls are adjusted in a way that put direct pressure on the internal pump stop). You will feel the slight resistance. There is no need to start the engine while checking this incrementally.

If the rod is made longer it will increase the forward speed capability for that side of the mower and if the rod is made shorter it will slow down that side of the mower. So, if the mower is tracking to the left, either the left side needs to go faster (by lengthening the left-side rod) or the right side needs to go slower (by shortening the right-side rod). If the mower is tracking to the right, either the right side needs to go faster (by lengthening

the right-side rod) or the left side needs to go slower (by shortening the left-side rod). It is important that neither rod should be lengthened too far, as mentioned above.

After getting the mower to track straight, readjust the neutral adjustment on the pump by using a ¼" allen wrench at the Return-to-Neutral (RTN) mechanism, if necessary. It is normal to make these adjustments from time to time.

## 5.9 How to Test/Use the Blade Clutch/Brake Switch



**WARNING**

Before testing the blade clutch/brake operation, make sure the area is clear and there is nothing vulnerable to thrown objects from under the mower. No one should be near the mower deck or in its line of discharge. The discharge chute deflector should be in the down position. The parking brake should now be applied. Move the engine throttle to ¾ speed setting. When mowing, the engine speed should always be at its highest setting. The engine governor will regulate the engine according to the different mowing conditions at that setting. Place both feet firmly on the foot platform and turn on the blade clutch switch. Run blades for a minute or so. Try engaging and disengaging the blades a few times about 10 seconds apart. If the blades do not start and stop in a few seconds each time, service the blade brake system or contact your local Wright dealer. Under mowing load, the clutch's life will be the greatest if engaged and disengaged at the ¾ throttle level.

## 5.10 How to Test the Operator Presence Control (OPC) Switch

With the parking brake applied and the blades ON, try lifting your feet off the foot platform to test the Operator Presence Control switch (OPC). The engine should kill and the blades should stop within a few seconds. If not, service the OPC system or contact your local Wright dealer.

Foot Platform  
OPC switch is  
located on the  
right side  
under hydro  
pulley guard



Brake OPC  
Switch is  
located on  
the left side  
under the  
dash panel

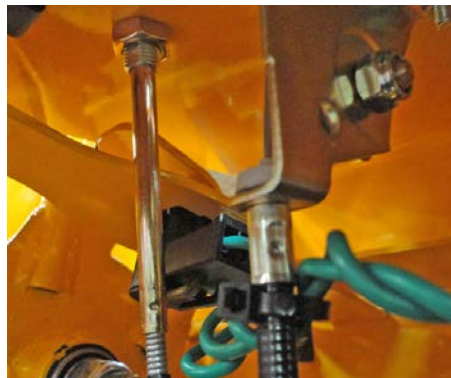

# 6 Service and Adjustments

For service documents go to [www.wrightmfg.com](http://www.wrightmfg.com), select support, then, click service docs tab.

## 6.1 Tire Maintenance and Pressure



**WARNING**

Excessively worn tire tread is dangerous on all hills. Replace drive tires with less than 3/32" of any tread groove left. Use tires with the tread pattern recommended by Wright Mfg., Inc. only. Keep the tire pressure in the drive tires between 18 and 22 psi. Higher pressures will cause the tires to have less traction, which will force you to go slower and with less safety and give you a harder ride. Front Casters are equipped with non-pneumatic tires and do not require any air. They do not have any tread but should be replaced when excessively worn. Lowering the tire pressure below the recommended pressure will change the pitch of the deck which may require further deck pitch adjustment.



## 6.2 Height-of-Cut

Before adjusting the height-of-cut be sure the mower engine is off, and rear tires have proper air pressure. Check for even tire wear. The height-of-cut can be adjusted the following way:

- While holding the deck lift lever grip to the left of the upright, push down (with thumb or other hand) on the button at the top of the deck lift lever. With the button pushed down, move the deck lift lever forward to lower the deck or pull back to raise the deck. When the deck is at the desired height, release the button and make sure the internal stop block is fully locked into place. There is also a detent pin that can be used to insure the deck is not lowered to a cutting height that is lower than the lowest desired cutting height.



### 6.2.1 Deck Lift Spring Adjustment

Deck lift spring tension is adjusted at the factory. If the effort needed to raise and lower the mower deck is not satisfactory, an adjustment may be necessary. The Intensity is equipped with two deck-lift assist springs. The left side spring behind the thigh pad is non-adjustable (1).

Do not over tension the deck lift adjust spring as the mower deck may float too freely.

To adjust deck spring tension, tighten or loosen the eye-bolt Nylock jam nut located in the front tank bracket. If tightening for more lift assist make sure not to over tighten creating the deck to hop over rough terrain.

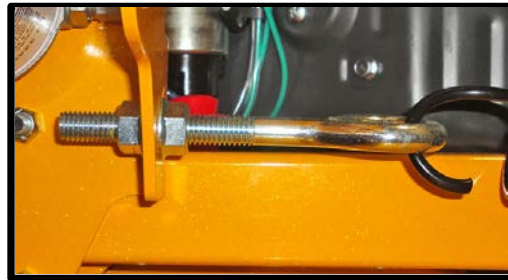

### 6.2.2 Deck Adjustments

The mower deck can be adjusted for pitch and side-to-side leveling. Pitch is the relationship between the front of the deck and the rear of the deck in regards to height of cut. In most cases, a positive pitch (front of the deck lower than the rear of the deck) of  $\frac{1}{4}$ " is the optimum setting. These adjustments can easily be made by moving any or all of the four deck lift brackets up and down using a  $\frac{1}{2}$ " ratchet & short extension. It is best to use blocks to lower the deck onto to assist in the deck adjustments.

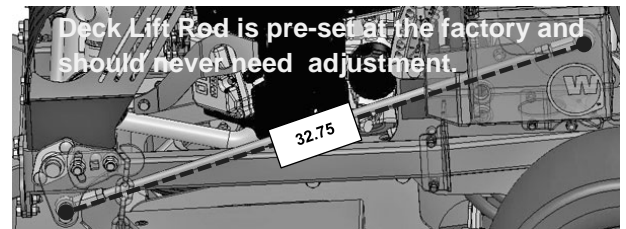

- Park mower safely on a level surface and inflate tires to the correct pressure.
- Set deck pin and lower deck to 3" height of cut. (If using blocks place under deck prior to lowering)
- Align blades front to rear, measure front and rear blade tips to grounds. The front blade tip should be 3" and rear should be between  $3 \frac{1}{8}$  –  $3 \frac{1}{4}$ ".
- Using a  $\frac{11}{16}$  wrench, loosen the deck lift bracket nuts (A). Using the  $\frac{1}{2}$  ratchet & extension, raise or lower the deck lift arm accordingly.
- Tighten to 45 ft. lbs. After all adjustments are made, verify measurements.



Left Front

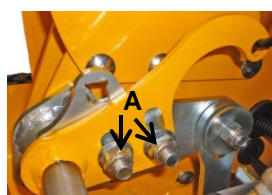

Left Rear

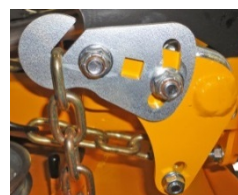

Right Front



Right Rear

## 6.3 Belt Tension Adjustment

The pump drive belt is self-adjusting, and requires no adjustment, just replacement. The blade drive belt is self-adjusting also and requires no adjustment, just replacement.

### 6.3.1 Replacing the Drive Belt

- Stop the engine, remove the key and wait for all moving parts to stop.
- Remove the deck covers and remove the engine to blade belt. (Refer to replacing the cutter deck belt section)
- Remove retaining knob (A), and remove the access panel (B).
- Remove the belt by using a ½” ratchet and extension to relieve the belt tension (C).
- With belt tension released, remove the belt from around pump pulleys.
- To remove the belt from around the idler pulley, it must pass between the bottom of the engine deck and the top of the idler pulley. It may be necessary to loosen the idler arm nut (D) and pull the idler arm/pulley in the downward motion (E) to allow clearance to remove the belt.
- Reinstall in reverse order. Figure shows belt routing and spring compression direction.

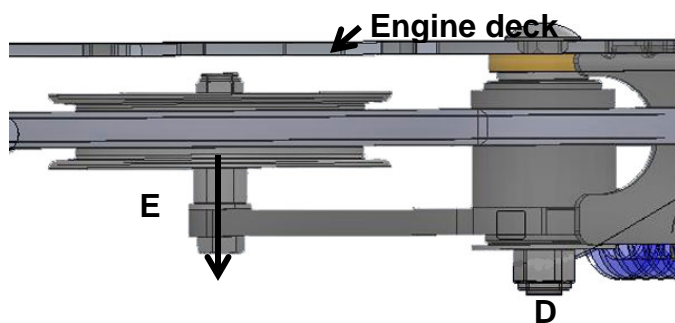
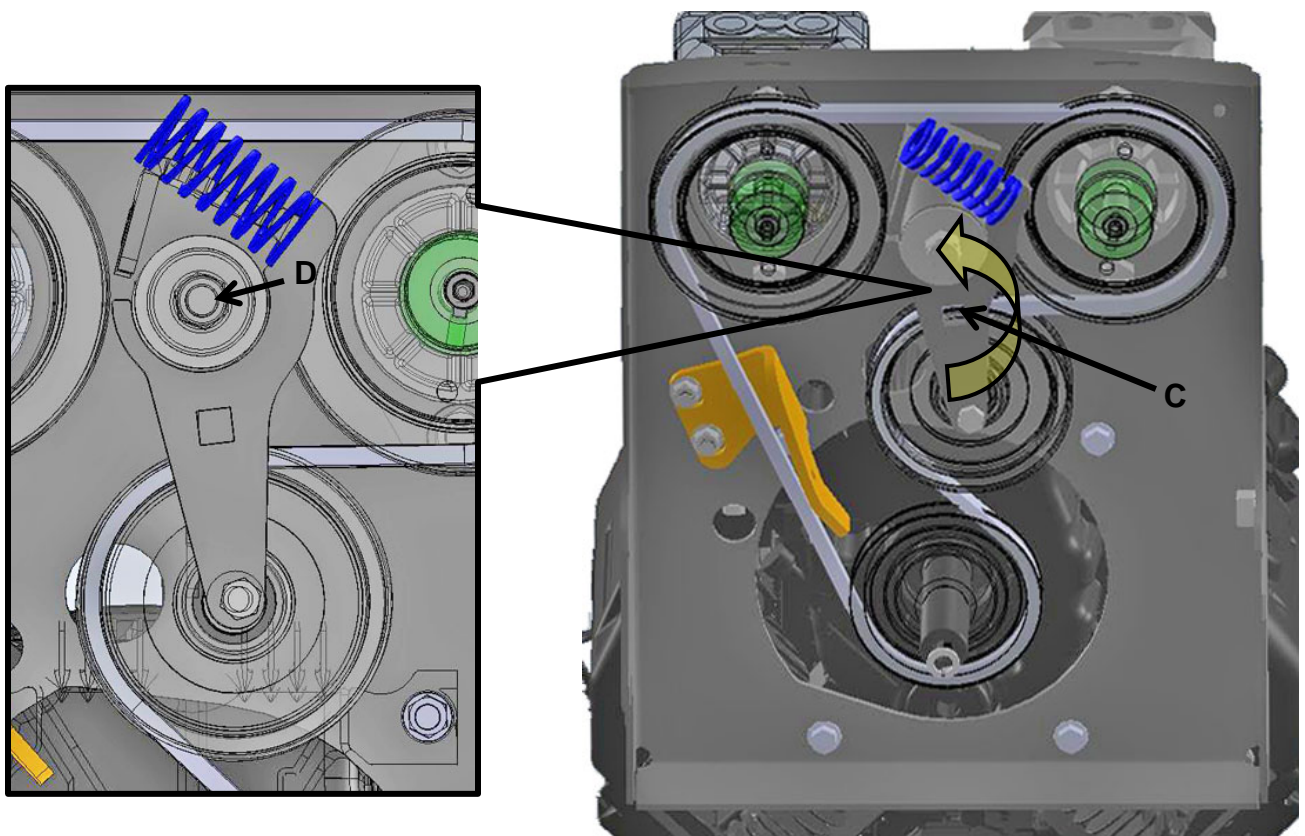
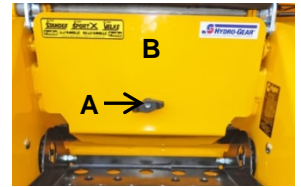

### 6.3.2 Replacing the Cutter Deck Belt(s)

- Stop the engine, remove the key and wait for all moving parts to stop.
- Lower deck to the lowest setting.
- Remove the deck cover(s).
- Remove the belt by using a ½" ratchet and extension to relieve the belt tension.
- Reinstall in reverse order. Figure shows belt routing and spring compression direction.

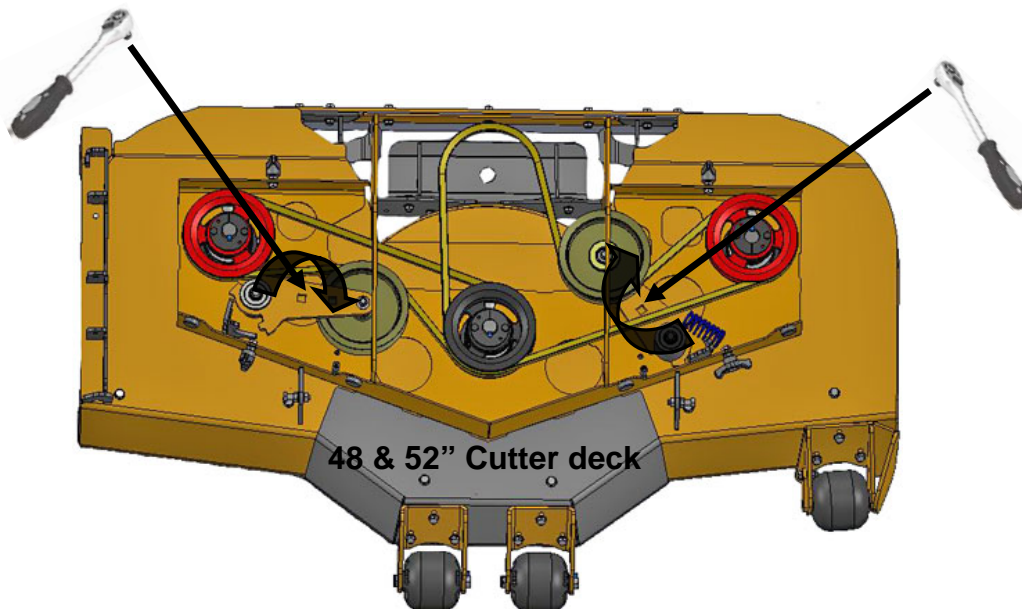
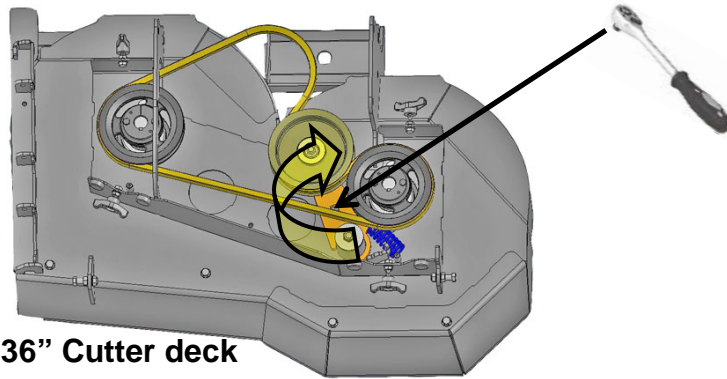

## 6.4 How to Move the Mower if the Engine Won't Start

Rotate both of the hydro bypass valve levers on the side of each hydraulic pump about ½ turn counterclockwise. It is important not to over tighten these levers. Damage may occur to the pump if this valve is over tightened.

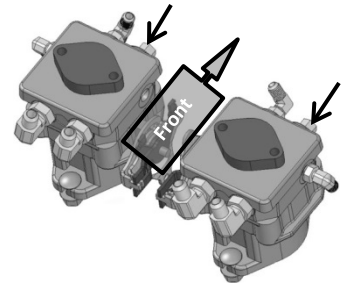

## 6.5 Hydraulic System

Whenever servicing the hydraulic system, *it is of the utmost importance to keep any dirt or debris from getting into the system.* Clean off all parts before disassembly and assembly. When any of the hydraulic parts are disconnected or removed or when the oil is changed, air must be bled from the system. If air is entrained in the system, loss of power, excessive heat, and damage to the hydraulic pumps may occur.

- Low Pressure Hose ..... →
- High Pressure Hose ———→
- Arrow Indicates Direction of Flow →

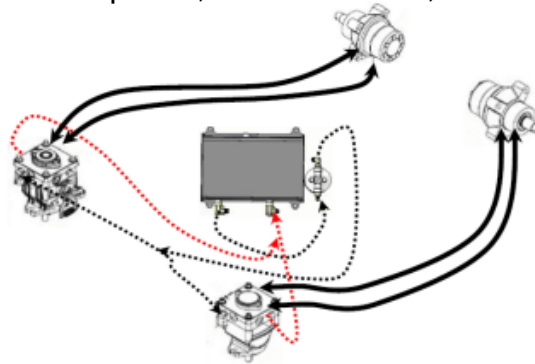

## 6.6 Hydro Oil Tank Check/Fill

### Checking oil

- Ensure mower is on a level surface.
- Lift hinged pad.
- Hydro oil should be in the center of the sight glass.

### Filling oil

- Lift hinged pad and remove vent cap from top of hydro tank.
- Using a funnel, fill tank until oil reaches the center of the sight glass.

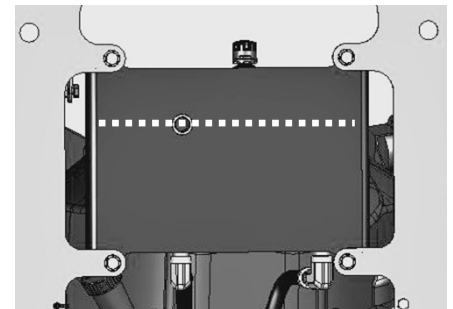

## 6.7 Bleeding Air from the Hydraulic System

If air is entrained in the system, loss of power, excessive heat, and damage to the hydraulic pumps may occur. First, make sure the oil level in the reservoir is correct. The oil should be level with the bottom threads of the oil level port. Use fully synthetic oil: Mobil1 15W-50. Lift the mower so that the rear wheels are off the ground. Be careful to support the mower so that it will not fall or tip while the system is bled of air. With the bypass valves open and the engine running, slowly move the control levers back and forth five or six times. Now close the bypass valves and with the engine running, slowly move the control levers back and forth five or six times. It may be necessary to repeat the above steps until all the air is purged and the rear wheels are turning at normal speed. After purging is complete, adjust the oil level in the reservoir if necessary.

## 6.8 Battery Service

The battery is 12 volts and is a maintenance free battery. Charge the battery only if it will not start the mower properly. Remove the battery from the mower before charging. Follow the instructions of the battery charger for proper and safe charging of the battery. To access the battery, first, park the machine safely. Remove the retainer knob (A) and remove battery cover (B).

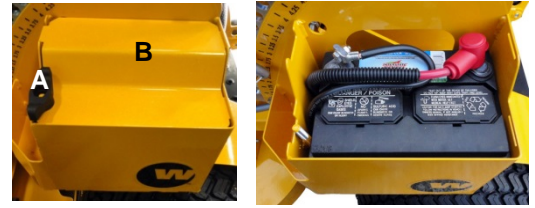

## 6.9 Parking Brake Adjustment



To test if the parking brake needs adjustment, inflate tires to the correct pressures. Stop machine on a maximum 17 degree slope and apply the brake. Properly adjusted brakes will prevent the wheels from turning. If the drive wheels turn, a brake adjustment will be necessary. Adjustment nuts are located between the fuel tank and upright.

To adjust brake:

- Loosen adjustment nuts. (A)
- Bring brake shoe down until contact is made with the tire. (B)
- With brake shoe making contact with the tire, move the brake handle to approximately 30 degrees (C) and tighten adjustment nuts. (A)
- Test parking brake. Adjust again, if required

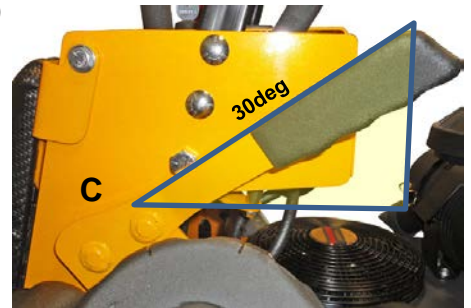
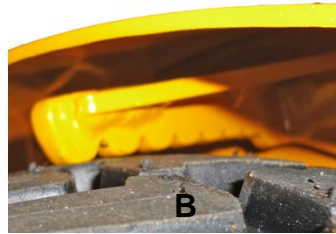

## 6.10 Lubrication

The Wright Stander I is made with sealed bearings, oil based bushings and with limited grease fittings therefore only the front caster pivots need to be greased. Grease yearly by either, removing the 1/4-28 bolt and install a grease fittings or by removing the dust cap, disassembling and re-packing the wheel bearings. Use Mobil Polyrex-EM grease. Use care filling with grease gun as too much pressure could blow out the grease seal.



## 6.11 Cutting Blades

In order to maintain the best cut, it is important that the blades are well sharpened and not damaged. Bent or cracked blades or blades with large nicks need to be replaced. Blades must be balanced after sharpening. To change the blades:

- Stop engine, remove the key and wait for all moving parts to stop.
- Engage the parking brake
- Lift front of mower and secure in the raised position with jack stands.
- Remove the blade bolt by turning counterclockwise.
- Apply anti-seize to the blade bolt.
- Install new or re-sharpened blade, start mounting bolt by hand. (Ensure the blade spacers are reinstalled with the same qty and location)
- Torque blade bolt to 70-80 ft/lbs / 95-108 Nm

## 6.12 Fuel Evaporation System

All Wright Stander I's need to have this mandatory feature.

- Do Not alter or remove.
- Do Not fill past the "Max Fill Level" line.
- Over-filling could result in clogging the roll-over vent and/or contaminating the purge canister.
- The vapor canister is located under the dash.
- Inspect and clean dust filter every 500 hrs or annually.



PN	DESCRIPTION	QTY
11990063	SCREW, TRUSS HEAD, PHILIPS, 1/4-20 x 1/2 SS	3
11990123	BOLT, CARRIAGE, 3/8-16 x 2 1/2 Z5	3
11990133	BOLT, HEX, 1/4-20 x 3 Z5, TAP	2
12990006	NUT, LOCK FLANGE, 1/4-20 Z5	2
12990008	NUT, FLANGE 3/8-16 Z5	3
12990012	NUT, U, 1/4-20, 11GA	3
15990042	CLIP, VINYL COATED 1/2 ID	2
24240002	HOSE, 1/4" ID, LOW PERM, PER FT	1
42420004	HOSE, 3/16 ID FUEL (NOT LOW PERM)	1
42420004	HOSE, 3/16 ID FUEL (NOT LOW PERM)	1
43410001	1/4" HOSE CLAMP	1
43410003	HOSE EAR CLAMP 13.3mm	1
45410025	TANK ASSEMBLY, 6GAL BLOW MOLDED (CARB-EPA)	1
45410026	232441 6.3 gallon 400 cc REV 5	1
91410048	FUEL TANK STRAP	2
93410387	SPACER, 5/8OD X 0.083W X 1.5IN	3
93410375	FUEL TANK STAND WELDMENT, WSTN	1

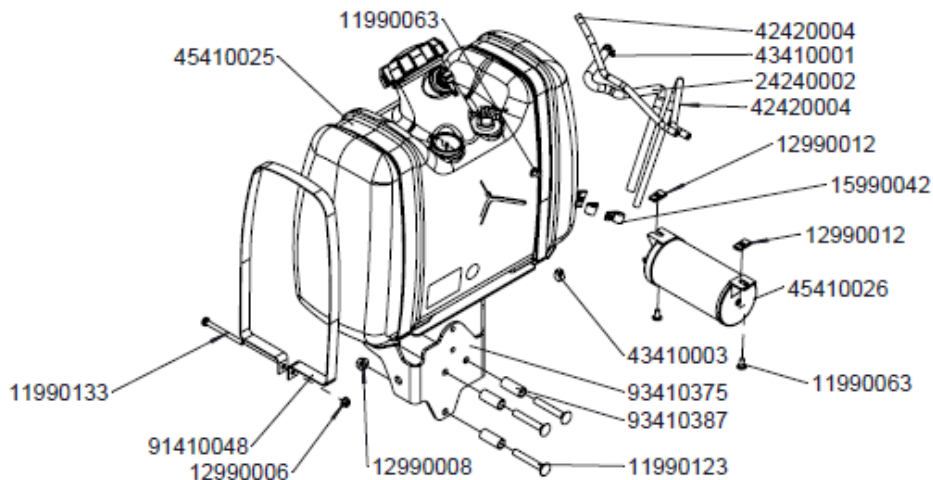

## 6.13 Spindle Pulley Split hub R&R



- Remove 2, 1/4" bolts from split hub and install in threaded holes in hub.
- Slowly tighten each bolt, alternating as you tighten bolts against the pulley.
- The hub will separate from the pulley.
- Replace grade 8 bolts and install in reverse order using the assembly holes to tighten hub onto pulley and spindle shaft.

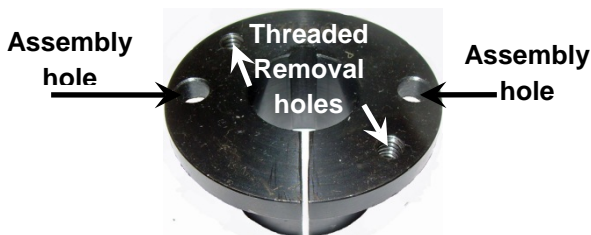

## 6.14 Loading and Unloading

Use extreme caution when loading and unloading units on/off trailers or trucks. One full width ramp that extends beyond the rear tires is recommended rather than individual ramps for each side of the unit. The ramp should be long enough so that the angles between the ramp and the trailer or truck does not exceed 15 degrees. A steeper angle may cause the mower deck components to get caught as the unit moves from ramp to trailer or truck. Always put the deck in the transport (up & locked) position when loading or unloading. Never attempt to turn the mower around on the ramp. Avoid sudden acceleration when driving up a ramp and sudden deceleration when backing down a ramp.

## 6.15 Transporting

Use a heavy duty trailer or truck to transport the Stander Intensity. Lock brake and block wheels. Securely fasten the unit to the trailer or truck with straps, chains, cable or ropes.

- Fasten unit to trailer or truck using tie down locations shown in photos.

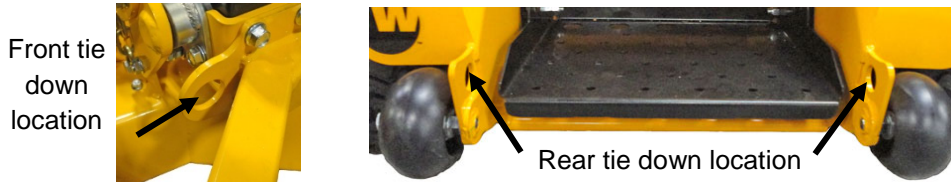

## 6.16 Cleaning the Mower

The underside of the mower deck should be checked and cleaned twice daily, and more often if the grass being mowed is lush or wet. The entire mower should be cleaned daily at the end of the work day.

Cleaning should be done with a leaf blower or low-pressure compressed air. Wash with water only when necessary and do not use a pressure washer or nozzle as the water can enter electrical connections causing an electrical short, rust and corrosion. When washing with water, do so when the unit has cooled down. Washing a hot machine can cause various unseen system damage. If water is used for cleaning, immediately dry it with a leaf blower or low-pressure compressed air. Once the wash is complete, always lubricate and grease all applicable areas.

## 6.17 Kawasaki Engine Manual / Maintenance

It is very important that all users of this unit read and understand the Kawasaki Engine Owner's Manual. This manual contains; safety awareness, emissions, maintenance and warranty information that is critical for the care of your Kawasaki engine. Below is the periodic maintenance chart directly from the Kawasaki Owner's Manual, which is included with the sale of the Stander Intensity.

○ The service intervals can be used as a guide. Service more frequently as necessary by operating conditions.

◆ : Service more frequently under dusty conditions.

K : Service to be performed by an authorized Kawasaki dealer.

MAINTENANCE	INTERVAL								
	Daily	First 8 hr.	Every 25 hr.	Every 50 hr.	Every 100 hr.	Every 200 hr.	Every 250 hr.	Every 300 hr.	Every 500 hr.
Check and add engine oil.	•								
Check for loose or lost nuts and screws.	•								
Check for fuel and oil leakage.	•								
Check battery electrolyte level.	•								
◆ Check or clean air inlet screen.	•								
◆ Clean air cleaner foam element.			•						

### Tune-up Specifications

ITEM	Specifications
Ignition Timing	Unadjustable
Spark Plugs: Gap	NGK BPR4ES 0.75 mm (0.030 in)
Low Idle Speed	1 550 r/min (rpm)
High Idle Speed	3 600 r/min (rpm)
Valve Clearance	In 0.10 ~ 0.15 mm (0.004 ~ 0.006 in) Ex 0.10 ~ 0.15 mm (0.004 ~ 0.006 in)
Other Specifications	No other adjustment needed

MAINTENANCE	INTERVAL								
	Daily	First 8 hr.	Every 25 hr.	Every 50 hr.	Every 100 hr.	Every 200 hr.	Every 250 hr.	Every 300 hr.	Every 500 hr.
◆ Clean air cleaner paper element.					•				
◆ Clean dust and dirt from cylinder K and cylinder head fins.					•				
Tighten nuts and screws.					•				
Change engine oil.		•			•				
Clean and regap spark plugs.					•				
Change oil filter.						•			
◆ Replace air cleaner paper element						•			
K Clean combustion chamber.								•	
K Check and adjust valve clearance.								•	
K Clean and lap valve seating surface.								•	

# 7 Electrical Schematic

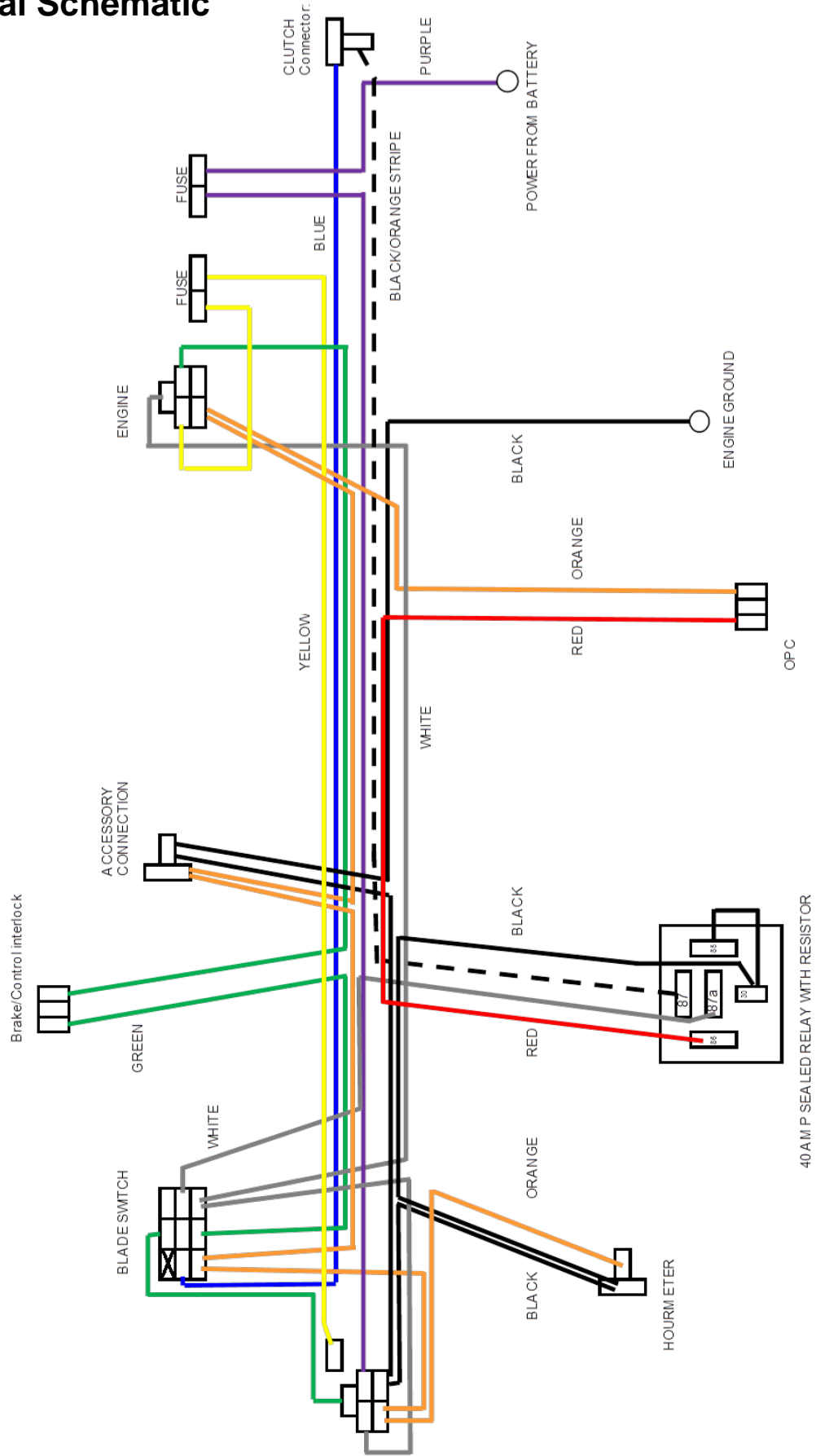



# 8 Decals



76990006  
DECAL, STANDER INTENSITY

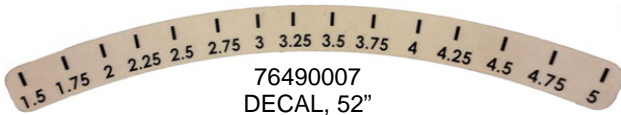

76490007  
DECAL, 52"

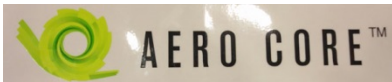

76490100  
DECAL, AERO-CORE DECK

**wright**  
HEAVY DUTY COMMERCIAL

- Twin Hydro Pumps
- Twin Hydro Motors
- 7 Ga. Fabricated Deck
- Cast Iron Spindle Housings

76490051  
DECAL, DECK COMMERCIAL BENEFITS



76410161  
DECAL, ALL LOGOS



76490059  
DECAL, AMERICAN FLAG

**36**  
76490015  
DECAL, 36"

**48**  
76490008  
DECAL, 48"

**52**  
76490007  
DECAL, 52"



76460001  
DECAL, DANGER BLADE HAZARD



76490001  
DECAL, SHIELD MISSING



76490023  
DECAL, CIRCLE WITH W



76490101  
MOWER PATENT NUMBERS

# 9 Maintenance Interval Chart

MAINTENANCE ITEM	ENGINE ITEMS	SEE NOTE BELOW	FIRST 8 HOURS	DAILY	EVERY 25 HOURS	EVERY 100 HOURS	EVERY 200 HOURS	EVERY 300 HOURS	ANNUALLY
Inspect for cracks in frame, cutter deck or other steel parts		*2	X						X
Inspect all belts for wear and alignment			X		X				X
Check all bolts and nuts for tightness (tighten as necessary)			X	X					X
Check hydraulic oil reservoir level and fill as needed (refer to Hydro Oil Tank Check & Fill section)			X						X
Grease caster yokes (refer to Lubrication section)			X						X
Inspect deck anti scalps wheels, ensure free moving				X					
Check tire pressure; Rear tires 18-22 psi			X	X					X
Check and clean engine cooling fins with compressed air	Engine	*1				X			X
Replace fuel filter (when clogged)	Engine	*1	X						X
Check engine oil and add as needed	Engine	*1		X					X
Check for fuel or oil leakage - correct as needed	Engine	*1		X					X
Check and clean air intake screen	Engine	*1		X					X
Clean engine blower screen with compressed air	Engine	*1		X					X
Clean mower with compressed air-do NOT use a pressure washer				X					X
Check for loose hardware (e-clips, snap rings, nuts, etc.)				X					X
Check blades for wear and sharpness (sharpen and balance or replace as necessary)				X					X
Clean out debris under blade belt cover				X					X
Scrape clean underside of cutter deck				X					X
Check blade mounting bolts for proper tightness				X					X
Check blade spindle mounting bolts for proper tightness				X					X
Inspect tires, replace as needed					X				X
Inspect and tighten all hydraulic hoses					X				X
Adjust parking brake shoes to firmly stop wheels when engaged					X				X
Clean and re-gap spark plug (replace as necessary)	Engine	*1				X			X
Change engine oil	Engine	*1	X			X			X
Change engine oil filter	Engine	*1					X		X
Replace air cleaner Primary Element	Engine	*1					250hrs		
Replace air cleaner Secondary Element	Engine	*1							500hrs
Replace hydraulic oil filter with Original Wright filter									X
Completely inspect for excessive wear in all parts of mower, including control system (replace worn parts)							X		X
Inspect and replace (if necessary) worn main cutter deck idler pulleys or pulley bearings (if applicable)							X		X
Replace (if necessary) excessively worn caster wheels							X		X
Remove battery and clean battery, battery box and battery cable ends							X		X
Check and adjust valve clearance	Engine	*1						X	

NOTES:  
 \*1 - Refer to Engine Manufacturers Owners Manual  
 \*2 - Contact an authorized Dealer immediately if any cracks are found  
 \*The service intervals indicated are to be used as a guide. Service should be performed more frequently as necessary by operating conditions\*



# WRIGHT MANUFACTURING, INC. POWER EQUIPMENT LIMITED WARRANTY

## SUPERSEDES ALL PREVIOUS WARRANTIES. EFFECTIVE FOR UNITS RETAILED ON OR AFTER 1/1/2016

### Limited Warranty:

Wright Manufacturing, Inc. (hereinafter: WMI) warrants to the original retail purchaser (Owner) and legitimate successors that any new WMI mower originally accompanied by this warranty with a retail sales date on or after the effective date above will be free from manufacturing defects in materials or workmanship subject to the following limitations and exclusions. Any part of the WMI commercial mower found, in the reasonable judgment of WMI, to be defective in materials or workmanship, will be repaired or replaced by an Authorized WMI Service Dealer without charge for parts and (except as excluded below) labor. This Warranty is transferrable with its remaining conditions to legitimate successor Owners to the original retail purchaser/owner. Dealer demo units with less than fifty hours when first retailed shall also be covered by this limited warranty. Proofs of Purchase will be required by the Authorized WMI Service Dealer to substantiate any warranty claims. All WMI warranty work must be performed by an Authorized WMI Service Dealer and mower must be delivered to the dealer prior to the expiration of the warranty period. This Warranty is limited to the following specified periods from the date of the original retail purchase for defects in materials or workmanship and will commence upon the date of original retail purchase. This warranty shall apply only if the warranty registration form has been completed on-line by an Authorized WMI Service Dealer and reflects the actual date of original retail purchase. This warranty includes only the cost of parts and labor (when applicable).

This warranty applies only to the replacement of defective or otherwise warrantable WMI OEM parts being replaced with WMI OEM parts.

- All parts and components (except as noted below)
  - 2 years/Unlimited Hours Commercial
  - 5 years/500 hours Non-Commercial\*
- Belts – 90 days
- Battery – 90 days
- Engine – warranty covered by engine manufacturer and handled through the respective Authorized engine dealers

### Exclusions:

Any damage or deterioration due to normal use, wear and tear or exposure  
All filters, engine oil, hydraulic oil, tires and tubes  
Bent, fractured or broken parts occurring through impact or hard use  
Clutch: linings, anti-rotation failure or other failure due to improper replacement installation  
Cost of regular maintenance service, parts or adjustments  
Worn bearings  
Worn bushings, cotters, clips, pins and retainers  
Grease/zerk fittings  
Paint, paint fading, cosmetic imperfections and steel surface imperfections  
Fabric, cushion and rubber grip wear or damage  
Cutting blades, light bulbs, fuses  
Any damage due to previous improperly performed or unauthorized repairs  
Fire or water damage  
Abrasion, rust or corrosion wear or damage

### Repair Parts Replaced During Original Warranty

All Repair parts (excluding wear or otherwise excluded items) installed during the original mower warranty period are warranted until the end of the respective original period according to the categories above except in the case that the respective original warranty period expires in less than ninety (90) days after the installation of the part(s). If this happens then the parts are warranted for a total of ninety (90) days from the time of their installation.

### Rental Use

The above warranty periods are limited to maximum of ninety (90) days for mowers that are used for rental purposes.

### Other conditions:

The WMI mower, including any defective part, must be returned to an Authorized WMI Service Dealer within the warranty period. The expense of lost production time and delivering the mower to the Authorized WMI Service Dealer for warranty work and the expense of returning it to the Owner after repair will be paid for by the Owner. WMI's responsibility is limited to making the required repairs and no claim of breach of warranty shall be cause for cancellation or rescission of the contract of sale of any WMI mower. This Warranty does not cover any mower that has been subject to misuse, neglect, negligence, burning in any fire, flooded by water, damaged in an accident, or that has been operated or maintained in any way contrary to the operating and maintenance instructions as specified in the Owner's Manual. The Warranty does not apply to any damage to the mower that is the result of improper maintenance or to any mower or parts that have not been assembled or installed as specified in the Owner's Manual. The Warranty does not cover any mower that has been altered or modified changing performance or durability. In addition, the Warranty does not extend to repairs made necessary by normal wear, or by the use of parts or accessories which, in the reasonable judgment of WMI, are either incompatible with the WMI mower or adversely affect its operation, performance or durability.

WMI reserves the right to change or improve the design of any mower without assuming any obligation to modify any mower previously manufactured.

All other implied warranties are limited in duration to the two (2) year warranty period or ninety (90) days for mowers used for rental purposes. Accordingly, any such implied warranties including merchantability, fitness for a particular purpose, or otherwise, are disclaimed in their entirety after the expiration for the appropriate two (2) year or ninety (90) day warranty period. WMI's obligation under this Warranty is strictly limited to the repair or replacement of defective parts and WMI does not assume, or authorize anyone to assume for them, any other obligation. Some states do not allow limitations on how long an implied warranty lasts, so the above limitation may not apply.

WMI assumes no responsibility for incidental, consequential or other damages including, but not limited to, expense for gasoline, expense of delivering the mower to an Authorized WMI Service Dealer and expense of returning it to the Owner, damage by fire, mechanic's travel time, telephone charges, rental of a like product during the time warranty repairs are being performed, travel, loss or damage to personal property, loss of revenue, loss of use of the power equipment, loss of time or inconvenience. Some states do not allow the exclusion or limitation of incidental or consequential damages, so the above limitation or exclusion may not apply.

This Warranty gives you specific legal rights, and you may also have other rights which vary from state to state.

This Warranty applies to all WMI commercial mowers retailed and located in the United States of America and Canada.

\*Non-Commercial: product is used only on one home lot. Use at multiple locations is considered commercial use in which the commercial warranty would apply.

**For the location of the Authorized WMI Service Dealer nearest you or other information, such as, Parts Lists and Owner's Manuals visit our website at: [wrightmfg.com](http://wrightmfg.com)**

**WRIGHT MANUFACTURING, INC.  
4600 WEDGEWOOD BLVD STE X  
FREDERICK MD 21703-7167**

## FEDERAL AND CALIFORNIA EMISSION CONTROL WARRANTY STATEMENT

### YOUR WARRANTY RIGHTS AND OBLIGATIONS

The United States Environmental Protection Agency (EPA), California Air Resources Board (CARB) and Wright Manufacturing, Inc. (WMI) are pleased to explain the evaporative emission control system (EECS) warranty on your 2014 - 2015 commercial mower. In the United States, new equipment that use small off-road engines must be designed, built and equipped to meet the Federal's stringent evaporative emissions standards. In California, new equipment that use small off-road engines must be designed, built and equipped to meet the State's stringent anti-smog standards. WMI must warrant the EECS on your commercial mower for the period of time listed below provided there has been no abuse, neglect or improper maintenance of your equipment.

Your EECS may include parts such as the carburetor, fuel-injection system, the ignition system, catalytic converter, fuel tanks, fuel lines, fuel caps, valves, canisters, filters, vapor hoses, clamps, connectors, and other associated emission-related components.

Where a warrantable condition exists, WMI will repair your commercial mower at no cost to you including diagnosis, parts and labor.

#### **MANUFACTURER'S WARRANTY COVERAGE:**

This evaporative emission control system is warranted for two years. If any evaporative emission-related part on your equipment is defective, the part will be repaired or replaced by WMI.

#### **OWNER'S WARRANTY RESPONSIBILITIES:**

- As the commercial mower owner, you are responsible for performance of the required maintenance listed in your owner's manual. WMI recommends that you retain all receipts covering maintenance on your commercial mower but WMI cannot deny warranty solely for the lack of receipts.
- As the commercial mower owner, you should however be aware that WMI may deny you warranty coverage if your commercial mower or a part has failed due to abuse, neglect, or improper maintenance or unapproved modifications.
- You are responsible for presenting your commercial mower to WMI's distribution center or service center as soon as the problem exists. The warranty repairs should be completed in a reasonable amount of time, not to exceed 30 days. If you have a question regarding your warranty coverage, you should contact WMI's warranty claims department at (301) 360-9810.

#### **GENERAL EMISSIONS WARRANTY COVERAGE:**

WMI warrants to the ultimate purchaser and each subsequent purchaser that the commercial mower is:

Designed, built and equipped so as to conform with all applicable regulations; and

Free from defects in materials and workmanship that cause the failure of a warranted part to be identical in all material respects to that part as described in WMI's application for certification.

The warranty period begins on the date the commercial mower is delivered to an ultimate purchaser or first placed into service. The warranty period is two years.

Subject to certain conditions and exclusions as stated below, the warranty on emission-related parts is as follows:

(1) Any warranted part that is not scheduled for replacement as required maintenance in the written instructions supplied, is warranted for the warranty period stated above. If the part fails during the period of warranty coverage, the part will be repaired or replaced by WMI according to subsection (4) below. Any such part repaired or replaced under warranty will be warranted for the remainder of the period.

- (2) Any warranted part that is scheduled only for regular inspection in the written instructions supplied is warranted for the warranty period stated above. Any such part repaired or replaced under warranty will be warranted for the remaining warranty period.
- (3) Any warranted part that is scheduled for replacement as required maintenance in the written instructions supplied is warranted for the period of time before the first scheduled replacement date for that part. If the part fails before the first scheduled replacement, the part will be repaired or replaced by WMI according to subsection (4) below. Any such part repaired or replaced under warranty will be warranted for the remainder of the period prior to the first scheduled replacement point for the part.
- (4) Repair or replacement of any warranted part under the warranty provisions herein must be performed at a warranty station at no charge to the owner.
- (5) Notwithstanding the provisions herein, warranty services or repairs will be provided at all of our distribution centers that are franchised to service the subject engines or equipment.
- (6) The commercial mower owner will not be charged for diagnostic labor that is directly associated with diagnosis of a defective, emission-related warranted part, provided that such diagnostic work is performed at a warranty station.
- (7) WMI is liable for damages to other engine or equipment components proximately caused by a failure under warranty of any warranted part.
- (8) Throughout the commercial mower warranty period stated above, WMI will maintain a supply of warranted parts sufficient to meet the expected demand for such parts.
- (9) Any replacement part may be used in the performance of any warranty maintenance or repairs and must be provided without charge to the owner. Such use will not reduce the warranty obligations of WMI.
- (10) Add-on or modified parts that are not exempted by the Air Resources Board may not be used. The use of any non-exempted add-on or modified parts by the ultimate purchaser will be grounds for disallowing a warranty claims. WMI will not be liable to warrant failures of warranted parts caused by the use of a non-exempted add-on or modified part.

**WARRANTED PARTS:**

The following emission warranty parts listed below are covered:

- (1) Fuel Tank
- (2) Fuel Cap
- (3) Fuel Line
- (4) Fuel Line Fittings
- (5) Clamps
- (6) Pressure Relief Valves
- (7) Control Valves
- (8) Control Solenoids
- (9) Electronic Controls
- (10) Vacuum Control Diaphragms
- (11) Control Cables
- (12) Control Linkages
- (13) Purge Valves
- (14) Vapor Hoses
- (15) Liquid/Vapor Separator
- (16) Carbon Canister
- (17) Canister Mounting Brackets
- (18) Carburetor Purge Port Connector

# Cut Quality and Mowing Tips

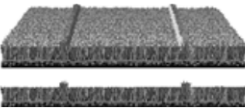
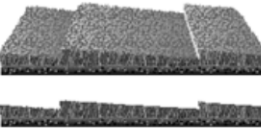
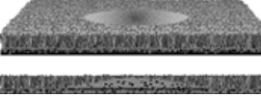
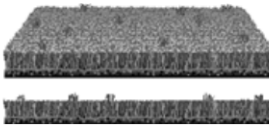
Problem	Description	Possible Cause	Solution
<b>Streaking</b>	<p>Streaking is when strips of uncut grass are left behind.</p> 	Blades are not sharp	Sharpen blades
		Blades are worn down too far	Replace blades
		Engine RPM is too low	Mow at full throttle
		GROUND SPEED IS TOO FAST	SLOW DOWN
<b>Stepped Cutting</b>	<p>Stepped cutting is sharp ridges left in the lawn surface. Stepped cutting is usually caused by deck damage or misadjustment, or blade damage</p> 	Deck is not leveled correctly	Level the deck
		Tires are not properly installed/inflated	Check and inflate tires
		Blades are damaged	Replace blades
		Deck shell is damaged	Repair or replace deck
		Spindle is bent or loose	Repair or replace spindle
		Blades are installed incorrectly	Reinstall the blades correctly
<b>Scalping</b>	<p>Scalping is when the deck comes close to or hits the ground. Scalping can be caused by the deck is misadjusted, unevenness in the lawn, or by deck bounce because ground</p> 	Lawn is uneven or bumpy	Roll or level the lawn
		Deck cutting height is set too low	Raise cutting height
		Deck is not leveled correctly	Level the deck
		Tire pressure is uneven	Check and inflate tires
<b>Stringers</b>	<p>Stringers are sparse patches of uncut grass left behind the mower.</p> 	Blades are not sharp or are nicked	Sharpen blades
		Blades are worn down too far	Replace blades
		Engine RPM is too low	Mow at full throttle
		GROUND SPEED IS TOO FAST	SLOW DOWN
		Deck is plugged with grass	Clean deck

Recommended Mowing Heights		
Grass	Minimum Height	Maximum Height
Tall Fescue	1 1/2"	3"
Kentucky Bluegrass	1 1/2"	2 1/2"
Bahia Grass	2"	3"
Bermuda Grass	1/2"	1"
St. Augustine Grass	1"	3"
Zoysia Grass	1/2"	1"

Mowing Tips
Always mow at full throttle
Check deck pitch, front blade tip MUST be 1/4" - 3/8" lower than the back of the blade tip.
Cut 1/3 of the grass blade, cutting more is not recommended unless grass is sparse
Use a slower ground speed when grass is wet and lush or when using a mulch kit.
Clean the under side of the cutter deck after each use. Grass build up WILL eventually effect cut quality.

**NOTES:**



**NOTES:**

**NOTES:**





4600X Wedgewood Blvd  
Frederick, MD 21703  
[www.wrightmfg.com](http://www.wrightmfg.com)