



Operator's Manual



STANDER SMALL FRAME

Serial # 114018 and higher until superseded
Revised 03/05/19
P/N 79510002

FAILURE TO FOLLOW SAFE OPERATING PRACTICES MAY RESULT IN SERIOUS INJURY OR DEATH.

Read this manual and other manuals that came with your mower before operating.

©1998-2019 Wright Manufacturing, Inc. All rights reserved. This material may not be reproduced or copied, in whole or part, without written permission from Wright Manufacturing, Inc. Grass Gobbler, Gobbler, Leaf Gobbler, Velke, Pro 1, X2, Stander, and Sentar are trademarks of Wright Manufacturing.

Table of Contents

1 INTRODUCTION	1-1	6 SERVICE AND MAINTENANCE	6-1
2 NEW MACHINE SETUP	2-1	How to Adjust Neutral	6-1
3 SAFETY PRECAUTIONS	3-1	Speed/Sensitivity	6-1
Important	3-1	Tracking Adjustments	6-1
Safety features	3-1	<i>Check Machine Tracking</i>	
Training	3-1	<i>Adjust Machine Tracking</i>	
Preparation	3-1	Reaching Maximum Capable Speed	6-1
Operating	3-2	Tire Maintenance and Pressure	6-1
Slope Specific	3-3	Troubleshoot No-Start Condition	6-1
Children Specific	3-3	Moving the Mower if it won't Start	6-2
Fire and Fuel Specific	3-3	Troubleshoot No-PTO Condition	6-2
Service	3-4	Height of Cut	6-2
4 MACHINE OVERVIEW	4-1	<i>Factory Settings</i>	
Specifications	4-1	<i>Temporary Adjustment with Caster Shims</i>	
<i>Engine</i>		<i>Blade Shims</i>	
<i>Electrical System</i>		<i>Front Caster Arms/Rear Motor Supports</i>	
<i>Drive System</i>		<i>Cut Setting Recommendations</i>	
<i>Hydro Oil System</i>		<i>Recommended Mowing Heights</i>	
<i>Fuel System</i>		Troubleshooting Cut Quality	6-3
<i>General Dimensions</i>		Belt Adjustment/Replacement	6-4
<i>Torque Specifications</i>		<i>Replacing the Cutter Deck Belt</i>	
Safety Interlock System	4-1	<i>Replacing the Drive Belt</i>	
Digital Hour Meter	4-1	Hydraulic System	6-4
Machine Features	4-2	<i>Bleeding Air from the Hydraulic System</i>	
<i>Overview</i>		<i>Checking oil</i>	
<i>Operator Area</i>		<i>Filling oil</i>	
<i>Control Panel/ Steering Levers</i>		Fuel Evaporation System	6-4
Warning, Safety, and Instructional Decals	4-3	Lubrication	6-4
Pictogram Meanings	4-3	Spindle/Drive Pulley R&R	6-5
5 OPERATION	5-1	Cutting Blades	6-5
Adding Fuel	5-1	Battery Service	6-5
Fueling	5-1	Loading/Unloading	6-5
Starting the Machine	5-1	Transportation	6-5
Driving the Machine:	5-2	Cleaning the Machine	6-5
Operating the Blade Switch (PTO)	5-2	Engine Manual / Maintenance	6-6
Operating the Operator Presence Control (OPC)		Maintenance Interval Chart	6-6
Switch	5-2	<i>Daily Visual</i>	
How to Stop and Park the Machine	5-2	<i>After 8hrs</i>	
Driving the Machine Over a Curb	5-2	<i>Every 100hrs</i>	
Mowing on Varying Terrain	5-3	<i>Every 300hrs</i>	
<i>Facing Uphill</i>		<i>Every 500hrs or Annually/Offseason</i>	
<i>Facing Downhill</i>		Maintenance Record	6-6
<i>Crossing a Slope Sideways</i>		7 WRIGHT MANUFACTURING, INC. POWER	
		EQUIPMENT LIMITED WARRANTY	7-1
		8 FEDERAL AND CALIFORNIA EMISSION CONTROL	
		WARRANTY STATEMENT	8-1

1 INTRODUCTION

Thank you for choosing to purchase our equipment. We are focused on giving you advanced engineering and quality construction in each machine we build. This manual explains the features and promotes safer use of the machine. Please read it in its entirety and follow the instructions carefully so that you can have many years of safe and productive operation with your Wright machine.

Your Wright dealer knows your machine and is interested in your satisfaction. Your dealer can provide you with quality maintenance and other assistance that you may need.

This manual is an important part of your machine and should remain with the machine when you sell it.

The owner's responsibilities include, but are not limited to, ensuring operators and mechanics read and understand this manual, adhere to its recommendations and procedures for safe operation, and maintain the machine for safe operation. The owner must not make assumptions as to the qualification of operators or permit careless or unqualified operators to have access to this machine. Wright reserves the option to make changes at any time without notice.

It is a violation of California Public Resource Code Section 4442 or 4443 to use or operate the engine on any forest-covered, brush-covered, or grass-covered land unless the engine is equipped with a spark arrester, as defined in Section 4442, maintained in effective working order or the engine is constructed, equipped, and maintained for the prevention of fire.

The Engine Owner's Manual contains information regarding the US Environmental Protection Agency (EPA) and the California Emission Control Regulation of emission systems, maintenance, and warranty. Replacements may be ordered through the engine manufacturer. Unauthorized changes to the engine, fuel or venting system, may violate EPA and CARB regulations.

Accident prevention regulations, other general safety regulations, occupational safety rules, and traffic regulations must be followed without fail.

WARNING

CALIFORNIA Proposition 65 Warning

The engine exhaust from this product contains chemicals known to the State of California to cause cancer, birth defects, or other reproductive harm. Battery posts, terminals, and related accessories contain lead and lead compounds, chemicals known to the State of California to cause cancer and reproductive harm. Wash hands after handling. Use of this product may cause exposure to chemicals known to the State of California to cause cancer, birth defects, or other reproductive harm. For more information go to www.P65Warnings.ca.gov.



SAFETY ALERT

This safety-alert symbol is used throughout the manual to identify potential hazards that may cause serious injury or death. To reduce the potential for injury, comply with these safety instructions, and pay attention to the safety alert symbol, which means Caution, Warning, or Danger—personal safety instructions. Failure to comply with the instructions may result in personal injury or death.

2 NEW MACHINE SETUP

WARNING

If you are not completely familiar with the Safety Instruction Manual read it now before proceeding with the Pre-Delivery Service of the mower.

The following items must be completed before attempting to operate a newly delivered machine.

1. Inspect the mower for any damage, missing parts, and labels.
2. Check for any recall or service notices.
3. Check and adjust engine oil.
4. Check and adjust hydraulic fluid level.
5. Check and adjust rear tire pressure – 18-22 psi. is recommended. A change in tire pressure may require the cutter deck to be readjusted.
6. Connect battery cables, red first, and then black.
7. Check the deck height select for proper operation and range.
8. Add regular unleaded gasoline to fuel tank.
9. Check brake and control interlock.
 - a. Try starting the engine with the parking brake released. (Engine should not start).
 - b. With the hand controls in the middle or neutral position, apply the parking brake.
 - c. Start the engine.
 - d. Check if the parking brake locking system prevents the machine from being driven while engaged. If not, service the brake system.
 - e. Release the parking brake. Move the control levers, one at a time, to make the wheels move in forward and backward rotation.
10. Test the Clutch/Brake
 - a. Insure the area is clear of people and objects that may be thrown.
 - b. Move the engine throttle control to $\frac{3}{4}$ RPM speed setting.
 - c. Turn on the blade clutch switch and check for normal operation.
 - d. Cycle the PTO a few times about 10 seconds apart. If the blades do not start and stop with-in 7 seconds each time, service the blade brake system.
 - e. With the blades on, disengage the OPC switch to test the Operator Presence Control switch (OPC). The engine should die and the blades should stop with-in 7 seconds. If not, service the OPC system.
 - f. Disengage the blades.
11. Drive the mower around an open level area. Check that the mower drives in a reasonably straight line.
12. Listen for any unusual noises and test for irregular operation and adjust or service as necessary.
13. Go over the safety information and operating procedures in this manual with the operator. Instruct each operator in proper operation and observe during initial operation on a level area. Repeat until the operator is familiar and comfortable with the basic operation and use of the mower.

Dealer:

Register the mower online within 14 days from the date of retail purchase. Registering the product indicates you have successfully completed the pre-delivery service checklist. The limited warranty is considered invalid unless the unit is registered and the above steps are taken.

Remember, the purchaser is both your customer and our customer and his/her satisfaction is very important. Thank you for supporting our products.

3 SAFETY PRECAUTIONS

Important

This machine is capable of amputating hands and feet and throwing objects. Failure to observe the following safety instructions could result in serious injury or death.

- This machine is constructed only for off-road use mowing grass on lawns without obstacles such as stones, tree stumps, and steep inclines.
- The machine can also be used for other tasks when equipped with approved attachments, for example the Grass Gobbler and Velke. Some accessories may void your warranty.
- Lawn machines and all power equipment can be dangerous if used improperly or by untrained operators.
- The owner/user can prevent and is responsible for accidents, injuries occurring to people, or damage to property.
- Only operate the machine in daylight or good artificial light. Failure to clearly see the ground while operating may result in sudden impact, loss of control, or thrown objects.
- Only operate the engine in well ventilated areas. Exhaust gases contain carbon monoxide, a deadly poison.
- Lightning can cause severe injury or death. If lightning is seen, or thunder is heard in the area, do not operate the machine.
- Do not operate the machine while tired, ill, or under the influence of alcohol or drugs.
- This machine is designed for use by physically fit, experienced, and professional commercial operators which must be no less than 120 pounds and no more than 325 pounds.
- Do not wear radio or music headphones or use a digital device. Safe service and operation require your full attention.
- Always follow OSHA approved operation.
- When machine is left unattended, stored, or parked, lower the cutter deck until it rests on a positive mechanical stop.
- Do not carry passengers and keep bystanders away.
- Do not carry equipment on the machine.
- When loading or unloading use only a full-width ramp which is wider than the machine, provides good traction, and is not positioned with a steep angle. Use caution when loading or unloading.
- When hauling, tie the machine down with appropriately rated straps or chains.
- Never leave or park the machine unattended on sloped ground or incline.
- Use only approved repair parts to maintain.
- Unauthorized modifications to the machine may impair its function and safety.

Safety features

The machine is designed with your safety in mind. It has the following safety systems with which you should become familiar:

- The warning decals on the machine including the instrument panel and cutter deck.
- The brake must be engaged and the PTO/blade switch “off” prior to starting the engine.
- The OPC switch must be actuated in order to engage the blades.
- Disengaging the Operator Presence Control (OPC) switch while the blades are running will cause the engine and blades to stop with-in 7 seconds.
- Spring loaded chute deflector helps reduce trajectory of thrown objects.
- Belt, pulley, fan, and heat covers on to reduce access to moving and hot parts.
- Anti-tip rollers provided at the rear of the machine reduce the risk of machine tipping.
- DO NOT disable any of the safety features.
- Unauthorized modifications to the design of the machine will absolve the manufacturer from liability for any resulting personal injury or property damage.

Training

- Read the operators manual, warnings, labels, attachments manual, engine manual, and other training material carefully. If the operator or mechanic cannot read the language provided, it is the owner’s responsibility to explain this material to them.
- Become familiar with the safe operation of the equipment, operator controls, and safety signs.
- All operators and mechanics should be trained. The owner is responsible for training the users.
- Never let children or untrained people operate or service the equipment. Local regulations may restrict the age of the operator.
- The owner/user can prevent and is responsible for accidents or injuries occurring to himself or herself, other people, or damage to property.
- Only allow operators, who are responsible, trained, familiar with the instructions, and physically capable to operate the machine.

Preparation

- Carefully inspect and walk the property where you plan to use the machine for hidden, hard-to-see objects or uneven ground that may be hidden in the grass. Uneven terrain could overturn the machine, or cause the operator to lose balance or footing.
- Clear the work area of moveable objects, including but not limited to, rocks, glass, toys, wires, dog chains/cables, and golf balls that might be picked up by the machine and dangerously thrown.

- Remove or mark the location of all immovable objects or irregular areas and be sure not to hit them with any part of the machine. Obstacles including and not limited to holes, abrupt changes in ground contour, tree trunks, stumps or roots, pipes or posts, paving edges, and rock outcroppings can abruptly turn or stop the machine. This could throw you off the machine or possibly over the handle bars causing serious injury or death.
- Check carefully for overhead obstacles (i.e. branches, clothes lines, doorways, electrical wire, decks, building overhangs, etc.) before operating and do not operate near them.
- Wear appropriate clothing and personal protective equipment; including safety glasses, long pants, substantial slip-resistant footwear, gloves, and hearing protection. Tie back long hair.
- Do not wear jewelry, sneakers, sandals, shorts, baggy clothing, or any clothing or accessories with loose loops or lanyards.
- Keep the area of operation clear of all bystanders, particularly small children. Stop the machine and attachment(s) if anyone enters the area.
- Check that the operator's presence controls, safety switches, interlocks, hardware, and shields are attached and functioning properly. Do not operate the machine unless they are functioning properly. Repair or replace damaged, badly worn, or missing parts
- Do not operate machine without the entire grass catcher, discharge chute, or other safety devices in place and functioning properly. Check frequently for signs of wear or deterioration and replace as needed.
- Ensure that all drives are in neutral and that the parking brake is engaged before starting engine. Start the electric start engines only from the operator's position.
- Before using, always visually inspect to see that the blades, blade bolts and the mower assembly are not worn or damaged. Never straighten or weld blades.
- Do not operate the machine faster than conditions allow. For example, hills, wet or bumpy ground, dim light or high grass are all conditions requiring slower speeds. Never operate the machine at the highest speed unless you are on level, wide, open areas of clearly visible ground or transporting on paved areas. Speeding with any machine is dangerous, and so is traveling faster than conditions should permit on this machine. Sudden stops from excessive speed or falling off the machine may cause serious injury or death.
- Know the controls and how to stop quickly.
- During zero-radius turns (when one machine wheel rotates backwards while the other rotates forward) drive extra slowly to reduce the possibility of losing traction, losing control, or losing your balance. This will help prevent you from being thrown off the machine.
- Use care when approaching blind corners, shrubs, trees, or other objects that may obscure vision.
- Slow down and use caution when making turns and crossing roads and sidewalks. Stop the blades if you are not mowing. Watch for traffic when operating near or crossing roadways.
- Turn off blades and wait for them to stop before crossing roadways, gravel areas, and climbing or dismounting curbs.
- Do not raise the mower deck with the blades running.
- Do not direct discharge material toward anyone. Avoid discharging material against a wall or obstruction. Material may ricochet back toward the operator.
- If the machine discharge clogs, turn off the blade clutch switch, apply the parking brake, stop the engine and remove the key before removing obstruction(s).
- Do not leave the machine running unattended. Always park on level ground, disengage the attachment, set parking brake, and stop engine.
- Stop on level ground, disengage drives, engage the parking brake, and shut off the engine before leaving the operator's position for any reason including emptying the catchers, unclogging the chute, and servicing the blades or cutter deck.
- Stop equipment and inspect the blades after striking objects or if an abnormal vibration occurs. Make the necessary repairs before resuming operations.
- Keep hands, feet and clothing away from rotating parts, especially the rear wheels, blades, engine flywheel, fans, belts and pulleys.
- Do not touch parts that may be hot from operation. Allow the machine to cool before

Operating

- Keep a firm hold of the stationary handle at all times. Keep both feet on the platform at all times.
- To prevent serious injury never place your foot or feet on the ground near the back edge of the machine while backing up.
- Do not suddenly push controls in forward direction while machine is in a rearward motion. Operate the controls smoothly.
- Do not mow in reverse unless absolutely necessary. Always look down and behind before and while backing to ensure a clear path. Use extra caution when operating in reverse.

attempting to maintain, adjust, service, unjamb, or service the machine.

- Do not put hands or feet near rotating parts or under the machine. Keep clear of the discharge opening at all times.

Slope Specific

- Before operating on slopes, walk the area and evaluate the surface for traction and smoothness. Slopes with drop offs, water, or compromised traction should be maintained through other maintenance techniques.
- Slow down and use extra care on hillsides. Be sure to travel in the recommended direction on hillsides. Turf conditions can affect the stability of the machine.
- Do not operate near drop-offs, ditches, embankments, or water. The machine could suddenly roll over if a wheel goes over the edge or the edge caves in. The machine could suddenly slide if traction is compromised. Leave a safety area between the machine and any hazard.
- Slow down and use caution when making turns and when changing directions on slopes.
- Slopes are a major factor related to accidents. Operation on all slopes requires extra caution.
- Establish your own special operating procedures and rules for operating on slopes. These procedures must include a survey of all mowing sites to determine which slopes are acceptable. Always use caution, and good judgement when performing this survey.
- Note that high traction conditions present a greater rollover hazard while lower traction conditions present a greater loss of control hazard. Ground and turf conditions vary depending on the weather and must be taken into consideration at all times.
- Some liquid landscape chemicals contain surfactants which may be very slippery and severely compromise safe operation.
- Do not operate on steep slopes.
- Do not operate the machine on slopes when the grass is wet.
- Do not operate machine under any condition where traction, steering, or stability is in question. Tires could slide even if the wheels are stopped.
- Always keep the machine in gear when going down slopes. Do not coast downhill.
- Avoid starting and stopping on slopes. Avoid making sudden changes in speed or direction. Make turns slowly and gradually.
- Use extra care while operating machine with a grass catcher or other attachment(s). They can affect the stability of the machine.
- There is a danger of suddenly sliding sideways or down the hill. When operating on a slope,

travel across the grade whenever possible, not in an up or down pattern.

- Reduce speed and exercise extreme caution on slopes and in sharp turns to prevent tipping or loss of control. Be especially cautious when changing direction on slopes.
- Do not operate tires that are worn beyond 3/32" of tread. Do not use unapproved treads or tire pressures. Unapproved treads or excessive pressures can compromise your traction.

Children Specific

- Death or serious injury can occur when young children associate having fun with lawn mowing equipment.
- Children who have been entertained with power equipment in the past may be attracted to the machine while operating. Children do not understand the hazards of rotating blades and moving equipment. Never use the machine as a recreational vehicle or to entertain children.
- Never allow children or untrained operators to operate the machine. Instruct all operators to not give children rides.
- Tragic accidents can occur if the operator is not alert to the presence of children. Children are often attracted to the machine and the mowing activity.
- Never assume that children will remain where you last saw them.
- Keep children out of the operating area and under the watchful care of a responsible adult other than the operator.
- Do not carry children, even with the blade(s) shut off. Children could fall off and be seriously injured or interfere with safe machine operation. Children who have been given rides in the past could suddenly appear in the mowing area for another ride and be run over or backed over by the machine.
- Do not allow children to play on or around machine when not in use and never leave the key in the ignition switch. Children may be injured by hot components and are prone to attempt operating all functions of the equipment which may result in becoming pinched, crushed, or unintended operation.

Fire and Fuel Specific

- Besides routine maintenance, one of the best ways to reduce the risk of fire is to regularly check and remove debris and combustible residue from the machine.
- Use extra care when handling fuels. They are flammable and vapors are explosive.
- Use only an approved container.
- Do not remove the fuel cap or add fuel with the engine running. Allow the engine to cool before refueling.

- Keep the machine and engine free of grass, leaves, excessive grease, oil, or other debris at all times to reduce the risk of fire.
- Do not use the machine to push combustible materials, such as leaves, branches, or tall grass.
- Never smoke when handling fuel, and stay away from open flame or where fuel fumes may be ignited by spark.
- Never start the engine in an enclosed space with the presence of fuel vapor. Starting the engine may ignite fuel vapors.
- Do not smoke near the machine when the engine is running.
- Do not refuel indoors or in enclosed spaces.
- Never overfill the fuel tank.
- Remove machine from truck or trailer before fueling.
- Do not store the machine or fuel container, or refuel, where there is an open flame, spark, or pilot light such as on a water heater or other appliance.
- If fuel is spilled, do not attempt to start the engine and avoid creating any source of ignition until fuel vapors have dissipated.
- Allow machine to cool before storing or covering. Machine fires and structural fires can occur if a machine is stored before allowing it to cool.
- Always shut off fuel when storing or transporting.
- Check fuel lines, tank, cap and fittings frequently for cracks or leaks. Replace immediately if necessary.
- Ensure all safety related switches are operational. Do not disable safety switches.
- Use caution when servicing blades. Wrap the blade(s) or wear gloves. Replace damaged blades. Do not repair or alter blade(s). Do not use blades that have been improperly sharpened or beyond the serviceable limits. Do not use blades from unverified sources as the material may not be suitable.
- Machines with hydraulic pumps, hoses, or motors: **WARNING:** Fluid escaping under pressure may have sufficient force to penetrate skin and cause serious injury. If fluid is injected into the skin, seek immediate medical attention. Keep body and hands away from pin holes or nozzles that eject fluid under high pressure. If a leak occurs, have the machine immediately serviced by a trained technician. Never use hands to search for hydraulic leaks. Use paper, cardboard, or UV dye. Keep body and hands away from pin holes or fittings that eject hydraulic fluid under high pressure.
- Disconnect spark plug wire(s) and the negative battery cable before making any repairs.
- The machine should not be used after the blades or other part of the machine strikes a foreign object, until conducting a thorough inspection and any damage is repaired.
- Do not climb underneath
- Do not service the machine while suspended by an unapproved lift, such as a forklift, or hoist/structure not approved for overhead lifting. Use proper lifts, or jack stands to support the machine.
- Don't change RPM's outside of operating limits or alter the governor operation
- Do not tow or push with force or over long distances. When moving stuck or disabled equipment, place transmission(s) in neutral or hydro bypass.
- Use tires with the original tread pattern. Use of alternate tires and treads may cause loss of control.
- Use of parts other than specified parts supplied by Wright Manufacturing, Inc. may compromise the safe use of the machine and not recommended. Their use could void the warranty. Always check with your Dealer or the Wright website, www.wrightmfg.com for the Part Lists and diagrams for your machine.
- Waste products, such as used oil, fuel, coolant, brake fluid and batteries, can harm the environment and people. Do not use beverage or unlabeled containers for waste fluids – someone may drink from them. Do not leave open containers where they can be accessed by children or animals.

Service

- Only qualified and trained persons who understand the warnings in this manual should service this machine.
- Examine the moving parts prior to each use. Look for excessive wear, deterioration, bald or worn tires, cracks in parts, lose or missing bolts, pins, and replace before operating the machine. Inspect fuel system for leaks or cracks in hoses, tank(s), and seals.
- Make sure all safety equipment provided with the machine is in good operating order, including all the warning decals and the required operator-presence device which stops the engine and blades when the switch is released.
- Inspect the two anti-tip rollers and their respective bolts at the rear of the machine for tightness and proper operation.
- Be sure that all parts of the hand-operated control system are tight and secure. This is to reduce the possibility that the machine could have a loss of control.

4 MACHINE OVERVIEW

Specifications

Engine

- See your engine owner's manual
- Full speed 3600 +/- 50 RPM
- No load/Idle: 1550 RPM

Electrical System

- Charging System: Internal stator coil
- Battery Type: Maintenance free
- Battery Voltage: 12 Volts
- Fuses: Two, 20 amp blade type

Drive System

- Hydro Gear 10cc variable displacement piston pumps
- Hydro Gear 12 cu. in. wheel motors

Hydro Oil System

- Hydro Oil: full SYNTHETIC I: Mobil-1 15W-50
- Hydro Filter: Spin-on, 25 micron, no bypass
- Tank Fill Level: Until fluid is visible in the sight glass

Fuel System

- Fuel Type: Unleaded regular gas, min 85 octane
- Fuel Filter: In line
- Fuel shut off: On, Off located on fuel tank
- Fill Level is 1" below the neck

General Dimensions

	32" Deck	36" Deck
Width, Chute down	45.5"	48.5"
Width, Chute up	33.5"	36.5"
Length	58"	60"
Height	47"	47"
Weight	605 lbs.	620 lbs.

Torque Specifications

Critical Application	Thread Locker	Torque (ft-lbs)
Wheel motor bolts	Loctite 2760	40-50
Clutch to engine shaft	Loctite 2760	50-55
Wheel hub to wheel motor	N/A	138-158
Wheel lug nuts	N/A	80-90
Split Hub (Spindle & Drive)	N/A	13-17
Blade Bolts	N/A	70-80

Safety Interlock System

The machine is equipped with a start interlock system. The PTO must be disengaged; brake applied and control levers in the neutral position in order to start the machine. With the brake applied, the controls are locked in the neutral position.

⚠ CAUTION

If the safety-interlock switches are disconnected or damaged, the machine could operate unexpectedly, causing personal injury. Do not tamper with the interlock switches. Check the operation of the interlock switches daily and replace any damaged switches before operating the machine

Digital Hour Meter

Hour meter counts the time that the ignition switch is on AND the platform is occupied. Operating/reset instructions:

- Default display: Hours
- Press once (TMR1): Timer 1, press for 3 sec to reset
- Press twice (TMR2): Timer 2, press for 3 sec to reset
- Press three times (svc ENG): Will display time remaining until next service point, hold down to reset. The first interval is 8hr, thereafter 100hr. Beginning 5hr before service point the meter will flash "svc ENG, in [remaining hours]" every 5 seconds.
- Shut off engine: Will display how many times the engine has started.

Machine Features

- This machine is meant to solely cut, bag or mulch grass.
- The use for any other purpose is not recommended.
- Do not disconnect any safety switches or remove any decals.

Overview

1. Flexible Chute Deflector
2. Rear Drive Tire
3. Fuel Tank w/ Vented Cap
4. Brake Handle
5. Battery Box
6. Front Caster Tire
7. Cutter Deck
8. Engine
9. Muffler/Heat Shield

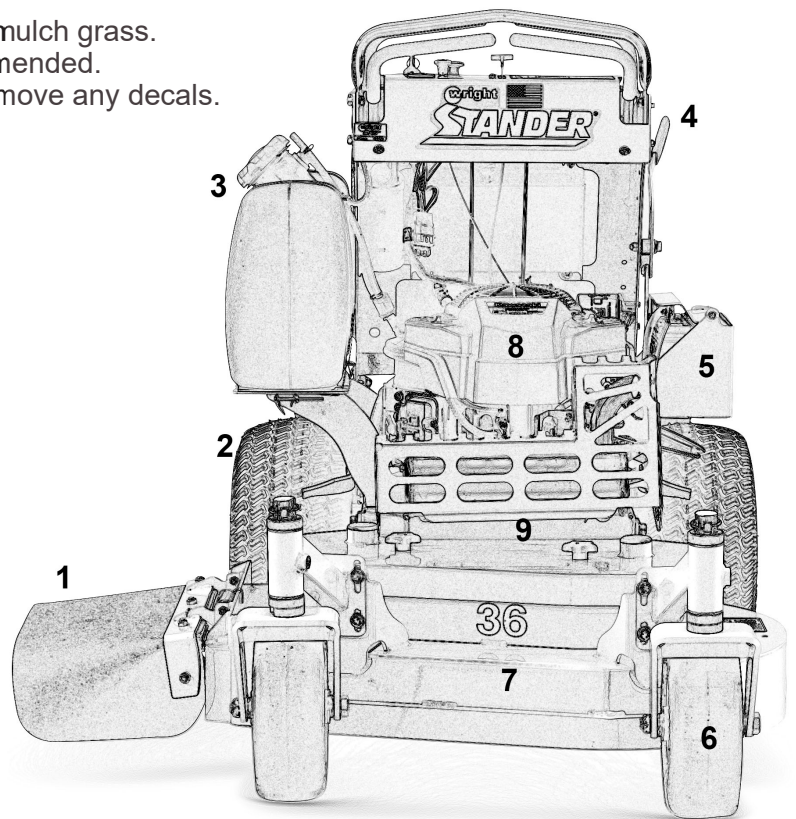

Operator Area

1. Anti-Tip Wheels
2. Battery Box
3. Brake Handle
4. Motion Control Handles
5. Dash Panel
6. Thigh Cushion
7. Foot Platform

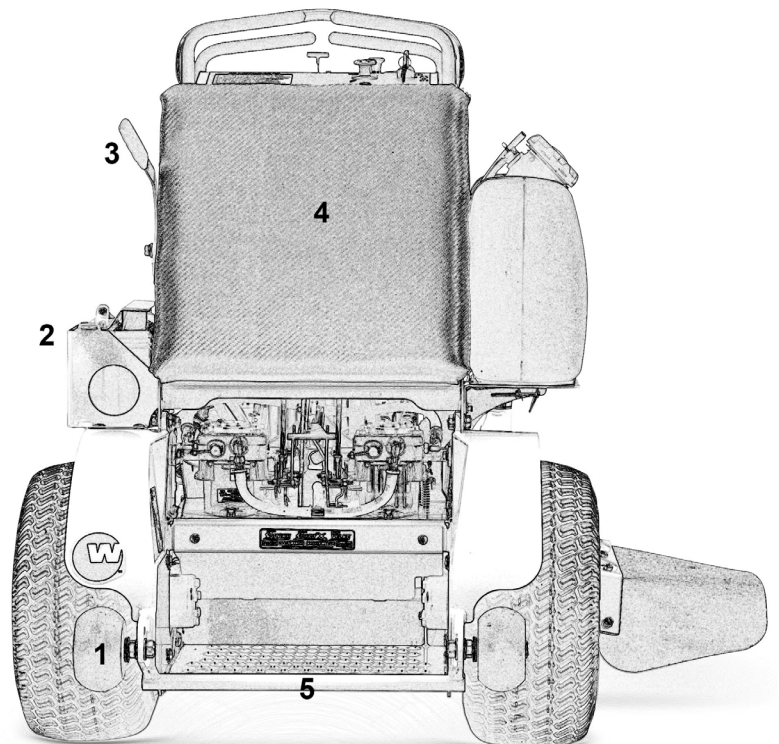

Control Panel/ Steering Levers



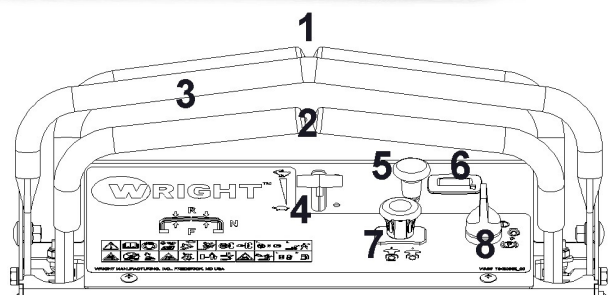

















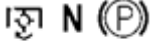

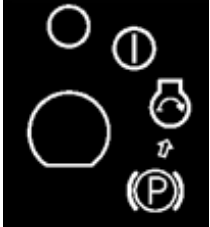

1. L/R Reverse Control
2. L/R Forward Control
3. Stationary Handle Bar
4. Throttle
5. Choke
6. Digital Hour Meter
7. PTO Switch
8. Ignition Switch



Warning, Safety, and Instructional Decals

- Specific safety warning decals are located on the equipment near immediate areas of potential hazards.
- Keep all safety signs legible - Replace worn, damaged or missing safety decals.
- Remove all grease, dirt and debris from safety signs and instructional decals.
- If an attachment or accessory has been installed, make sure current safety decals are visible

Pictogram Meanings

<p>1. </p> <p>2. </p>	Warning: Let the machine cool down prior to fueling		Warning: Inspect work area for objects that can be thrown or impacted
	Warning: Hot surface. Stay away.		Warning: Keep the cutter deck opening covered or the chute down while operating
	Engage hand brake		Warning: Entanglement hazard
	Engine speed control.		
	Pull switch to engage blades/PTO. Push switch to disengage blades/PTO.		Warning: Keep debris off machine at all times
<p>1. </p> <p>2. </p>	Warning: Stop the blades, place the controls in neutral and engage the brake before dismounting machine		Warning: Read the Operator's Manual. Do not operate this machine unless you are trained.
	Ignition: off, on, engage brake to start		Warning: Stay away from people and children. Do not operate the machine when children and/or others are around.
			Warning: Use eye and hearing protection
	Warning: Keep hands and feet away from moving parts		Warning: Thrown object hazard
	Warning: Keep shield and guards in place		Warning: Identifies potential hazards that may cause serious injury or death if you do not follow the recommended precautions.
	Warning: Do not operate near drop offs or water		Warning: Before servicing stop the engine, remove the key, and read the Operator's Manual
	Warning: Fire hazard		Warning: Operate slowly on any incline
	Warning: Thrown object hazard		Warning: This safety-alert symbol is used to identify potential hazards that may cause serious cutting or severing hands and feet

5 OPERATION

Basic Operation: The following procedures are to guide you through the basic operation of the machine. You should be a qualified machine operator according to the safety section of this manual. You should go through each step, in the order indicated, every time you start the machine.

⚠ CAUTION

This machine produces sound levels in excess of 85dBA at the operator's ear and can cause hearing loss from extended periods of exposure. Wear hearing protection when operating this machine.

Adding Fuel

⚠ DANGER

- In certain conditions, fuel is extremely flammable and highly explosive. A fire or explosion from fuel can burn you and others and can damage property.
- Fill the fuel tank outdoors, in an open area, when the engine is cold. Wipe up any fuel that spills.
- Never fill the fuel tank inside an enclosed trailer.
- Do not fill the fuel tank completely full.
- Add fuel to the fuel tank only to the bottom of the filler neck. This empty space provided allows fuel to expand.
- Never smoke when handling fuel, and stay away from an open flame or where fuel fumes may be ignited by a spark.
- Store fuel in an approved container and keep it out of the reach of children.
- Do not operate without entire exhaust system in place and in proper working condition.
- Never start the engine in an enclosed space with the presence of fuel vapor. Starting the engine may ignite fuel vapors.

⚠ WARNING

In certain conditions during fueling, static electricity can be released causing a spark, which can ignite the fuel vapors. A fire or explosion from fuel can burn you and others and can damage property.

- Always place fuel containers on the ground away from your vehicle before filling.
- Do not fill fuel containers inside a vehicle or on a truck or trailer bed because interior carpets or plastic truck bed liners may insulate the container and slow the loss of any static charge.

- When practical, remove gas-powered equipment from the truck or trailer and refuel the equipment with its wheels on the ground. If this is not possible, then refuel such equipment on a truck or trailer from a portable container rather than from a fuel-dispenser nozzle.
- If you must use a fuel-dispenser nozzle, keep the nozzle in contact with the rim of the fuel tank or container opening at all times until fueling is complete.
- Long-term exposure to vapors can cause serious injury and illness.
- Avoid prolonged breathing of vapors.
- Keep your face away from the nozzle and fuel tank or conditioner bottle opening.
- Avoid contact with skin; wash off spills with soap and water.
- Never siphon by mouth

⚠ WARNING

Fuel is harmful or fatal if swallowed.

Use only clean fresh fuel rated 87 octane or higher. Do not use fuel with more than 10% ethanol, such as E15, E20, or E85. Do not use fuel containing methanol, which is harmful to human health. Do not store untreated fuel in the machine when not used for more than 30 days.

Fueling

1. Park the machine on level ground in an open area, engage the parking brake, and remove the key.
2. Allow the machine to cool down before fueling.
3. Fill the tank to the bottom of the filler tube. Do not over fill to allow space for the fuel to expand.
4. Securely install the fuel cap.
5. Check for any leaking or spilled fuel prior to starting the engine.

Starting the Machine

Note: All engines consume oil. Before using, check the engine oil.

1. Before starting the engine, make sure the control levers are in the neutral position.
2. Apply the parking brake if it is not already set.
3. Turn OFF the blade switch if it is on.
4. Turn fuel valve to the "ON" position.
5. Start the engine according to the engine manufacturer's recommendation, see engine manual. Set the throttle control lever near mid throttle, pull out on the choke control knob (carbureted models) and turn the key to the start position.

- Do not engage the starter for more than ten (10) seconds at a time. This may overheat the starter and the wiring systems. Wait ten (10) seconds between attempts. If the engine does not start after several attempts or stalls frequently, take the machine in for service.
- After starting the engine according to the engine manufacturer's recommendation, push in on the choke control knob to open the choke valve.

Driving the Machine:

1. While standing, both feet should be firmly placed on the foot platform. Set the engine speed about 1/4 of the way from idle.
2. Release the parking brake.
3. Move the hand control levers, one at a time, very slightly, forward and backward. Check to see if the wheels move forward and backward according to the position of the levers. If not, check to see that the pump release valves are closed.
4. With both feet still firmly placed on the foot platform, increase the engine speed to about 1/2 from idle speed. The higher engine speed will make the controls much more responsive and the machine much quicker.
5. New operators should continue to practice driving the machine in an open area, with the blades off, at a partial engine speed.
6. Unusual noises or irregular operation: As you drive the machine, listen for any unusual noises and test for irregular operation and adjust or service as necessary.

Operating the Blade Switch (PTO)

⚠ CAUTION

Rotating blades may cause severe injury. Before engaging the cutter blades or PTO, make sure that the area is clear of bystanders, especially children.

1. Stand on the operator platform to engage the Operator Presence Control (OPC).
2. With the engine running, set the engine speed to approximately 1/4 to 1/2" position.
3. Pull the PTO switch up to engage the cutter blades.
4. Increase the engine speed to the fast position for mowing.

Note: Engaging and disengaging the PTO at full engine speed will not immediately harm the machine, however the life of the clutch will be much longer if the engine speed is reduced before engaging the PTO and again reduced before disengaging the PTO. This is especially true on larger width machines with more powerful EFI engines and mulch blades.

Operating the Operator Presence Control (OPC) Switch

1. With the parking brake applied and the blades ON, try lifting your feet off the foot platform to test the Operator Presence Control switch (OPC).
2. The engine should kill and the blades should stop within 7 seconds. If not, service the OPC system or contact your local Wright dealer. The OPC switch is located directly above the right side of the platform and the start/brake switch is located under the instrument panel.

How to Stop and Park the Machine

1. Come to a complete stop.
2. If the blades are on, turn them off using the switch on the instrument panel.
3. Make sure the control levers are in the neutral position.
4. Set the parking brake by pulling up on the brake handle.
5. Reduce the engine speed to idle.
6. Shut off the ignition switch to stop the engine and then remove the key from the ignition switch.
7. The machine is now parked.
8. Do not leave machine unattended on a sloped surface.

⚠ CAUTION

Children or bystanders may be injured if they move or attempt to operate the machine while it is unattended. Always remove the key and engage the parking brake when leaving the machine unattended.

Driving the Machine Over a Curb

It is recommended to use ramps for curbs 5" and higher. Using ramps, you can easily back on and off without damaging your machine or the curb.

1. Raise the cutter deck into the highest position.
2. Drive the machine in reverse at a 45 degree angle to the curb until you are within an inch or two of the left-rear tire hitting the curb.
3. Stop and then gradually bump into the curb with that tire until it is just on top of the curb.
4. If the tire slips then the curb is too high and you should use ramps.
5. While maintaining the same angle to the curb, continue to back up until the other rear tire climbs the curb.
6. After both drive wheels are on top of the curb, back up so the caster wheels comes over last.

- The technique works the best if you try not to drive backwards at a near 90 degree angle to the curb.
- To drive off a curb, reverse the procedure.
- Do NOT step off the machine during ANY maneuver.

Note: Never drive straight onto or off a curb or climb or “pop a wheelie” to climb a curb. Abruptly mounting and dismounting a curb increases the fatigue of the frame, transmissions, and caster wheels.

Mowing on Varying Terrain

⚠ WARNING

Operating the machine on or near slopes increases the hazard of rollover and loss of control and may cause severe injury or death. Refer to the SAFETY PRECAUTIONS section of the manual and follow the recommendations provided.

Facing Uphill

- Lean as far forward as possible to add your weight to the front of the machine.
- Accelerate gently. Do not accelerate quickly to avoid allowing the front wheels to lift off the ground.
- If backing down the hill, do not stop suddenly but slow down gradually.

Facing Downhill

- Machine has the least weight on the rear drive wheels and therefore the least traction at the tires. This is the angle that the machine has the most tendency to slide.
- However, this is the angle that it has the least tendency to tip back.
- Lean back with arms stretched out straight while holding onto the stationary handlebar. This transfers more of your body weight to the rear drive wheels for more traction.
- Do not change speed suddenly to minimize the tendency to slide.

Crossing a Slope Sideways

- Machine has the average amount of weight on the drive wheels versus the front wheels.
- This angle leaves the least weight on the higher side drive wheel, increasing the tendency to slip.
- However this is the preferred angle for mowing large areas of gentle slopes.
- Lean back and angle yourself to the higher side. This adds weight to the rear drive wheels and will provide greater traction.

⚠ DANGER

Without the discharge chute, discharge cover, or complete grass catcher assembly mounted in place, you and others are exposed to blade contact and thrown debris. Contact with rotating mower blade(s) and thrown debris cause injury or death.

Do not remove the chute deflector from the mower or permanently secure it in the transport position in a manner that overrides the closing spring. If the grass deflector is ever damaged, replace it immediately.

Never put your hands, feet, or head under the mower.

Never try to clear the discharge area or mower blades unless the Blade Switch (PTO) is off and the ignition key is removed.

6 SERVICE AND MAINTENANCE

How to Adjust Neutral

Neutral refers to the machine movement when the engine is set to full throttle, parking brake is off, and the control levers are in the neutral position. The machine should not move forward or backward in this state. If it does, the neutral setting must be adjusted by using the Return-to-Neutral (RTN) device built into the linkage of the hydraulic pump.

1. Lift the rear drive wheels off the ground using a jack and stands.
2. Loosen the 1/4" Allen bolt (A)
3. Rotate the RTN device on pump corresponding to the wheel that needs adjustment. Stop when the neutral position is found.
4. Retighten the 1/4" Allen bolt. Do not over tighten.

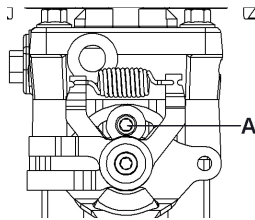

Speed/Sensitivity

The controls are initially set with the Speed/Sensitivity Adjustment in the faster, more sensitive position. Some operators may desire to decrease the ground speed. The slower setting has a corresponding decrease in the sensitivity of the controls. In other words, a given amount of movement of the control levers will cause about a 25-30% change in the ground speed making the controls less sensitive.

1. Stop the engine
2. Remove the bolts securing the control rods to the control levers
3. Re-install the rods into the alternate holes
4. BE SURE THE CONTROL ROD BOLTS ARE SECURELY IN PLACE EACH TIME YOU REMOVE THEM.
5. Perform the tracking adjustment



SLOWER FASTER

Tracking Adjustments

- Do not adjust the stationary control rods.
- Do not adjust rods such that the pump control lever (on the side of the pump) hits the internal pump stop while at full speed.
- This puts direct pressure on the pump stop and can damage the hydro pump.
- It can be identified by feeling resistance in the hand controls at the full speed position.

Check Machine Tracking

1. Ensure rear tire pressure is equal on both sides.
2. Drive at full throttle in a level parking lot.
3. Check if the machine drives straight when both control levers are in the full speed position. If it does not, tracking adjustment is needed

Adjust Machine Tracking

1. Ensure the machine is parked and engine is off.
2. Loosen the jam nut on the rods connected directly to the hydro pumps.
3. Adjust the rods.
 - Turning CCW lengthens rod and increases speed
 - Turning CW shortens rod and decreases speed
 - If the machine tracks to the left: lengthen the left rod or shorten the right rod.
 - If the machine tracks to the right: lengthen the right rod or shorten the left rod.

Reaching Maximum Capable Speed

(Only applies when in the "Faster" Speed/Sensitivity setting)

1. Lengthen the rods one turn at a time until you feel, in the hand control, the pump control lever contacting the internal pump stop.
2. Shorten the rods one full turn each.

Tire Maintenance and Pressure

- Excessively worn tire tread is dangerous on all hills. Replace drive tires with less than 3/32" of any tread groove left.
- Use tires with the tread pattern recommended by Wright Mfg., Inc. only.
- Keep the drive tire pressure between 18-22 psi.
- Higher pressures cause the tires to have less traction, decreasing safety, speed and ride quality
- Front Casters are equipped with non-pneumatic tires and do not require any air. They do not have any tread but should be replaced when excessively worn.

Troubleshoot No-Start Condition

1. Check that the battery is fully charged. If the battery repeatedly dies, check the regulator and charge wire going from the regulator to the starter battery stud.
2. Check that the fuel valve is fully open.
3. If battery is good and starter does not engage
 - a. Check that the park brake is engaged and the PTO switch is off.
 - b. Check the fuse under the instrument panel. Check the battery (+) and (-) wires to engine.
 - c. Check the harness ground wire at the engine. Check the harness power connection (red) where the battery cable is connected to the engine/solenoid

- a. Check the connections of the (green) start wire at the key switch, PTO interrupt switch, brake interlock switch, and starter.
- b. The starter may have failed. Check your engine manual.

Moving the Mower if it won't Start

- Rotate both of the hydro bypass valve levers about ½ turn CCW.
- DO NOT over tighten these levers.
- Damage may occur to the pump if this valve is over tightened.

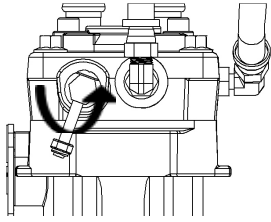

Troubleshoot No-PTO Condition

1. Engine runs but PTO won't engage.
2. Shut down machine, remove key, allow to cool, and checking the belt and wiring going to the clutch.
3. While the engine is off, disconnect the clutch wire, turn on the blade switch and check for battery power from the harness. The Blue wire that goes to the red clutch wire is power from the PTO switch. The black/orange strip wire going to the black clutch wire is the ground wire going to the relay, switch by the platform switch.
 - a. If no voltage, check relay, Operator Presence Switch, and PTO switch
 - b. If battery voltage is coming from the harness, check the clutch.
4. To check the clutch
 - a. Visually check the gap between clutch and the armature. If the gap is excessive the clutch is mechanically worn out of spec and must be replaced. A worn clutch may work when cold and not reengage once warm and the magnetic coil increases electrical resistance.
 - b. Use an ohm meter and measure the resistance in the clutch. It should be approximately 1.84 ohms. If the number is much lower the coil has likely shorted out. If the number is much higher (or infinite) there is likely a burnt or "open" coil.

Height of Cut

If you mow in an area of the country where the lawn is very thick and spongy you may have to adjust the cut height and blade angle as the tires "floating" or "sinking" on the lawn will cause differences from the blade height measured on a hard surface.

Before Adjusting the Height-of-Cut ensure proper air pressure in all tires and check for even tire wear.

Note: The angle of attack of the blades should always be level or lower at the front. This makes the blade cut the grass only once, saves fuel and wear on the whole mower, and allows more efficient mowing and grass catching or dispersal.

Factory Settings

- 32" Deck Size: 4 washers above caster, 2 C-Spacers/ 3 washers under caster

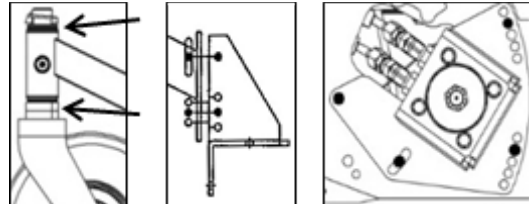

- 36" Deck Size: 7 washers above caster, 2 C-Spacers under caster

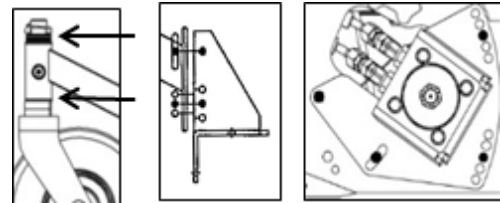

Temporary Adjustment with Caster Shims

- Coarse: By moving the C-spacers to be on top of the caster housing, you can adjust the blades downward .5" or 1" below the original setting.
- Fine: By moving the washers above and below the housing, you can adjust the blades up and down in .07" settings.

Blade Shims

- Adjust the blades equally in five settings up or down 0.25" each in a 1.25" total range.
- The shims on the blade bolts are moved from under the spindle to the top of the spindle.
- If possible, leave at least one shim at the top and the bottom of the spindle shaft.

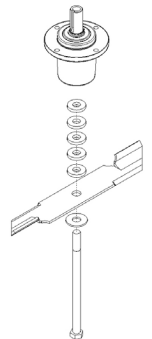

Front Caster Arms/Rear Motor Supports

- The front caster arm and the rear motor support should be adjusted at the same time, with the caster wheel shims at the factory setting.
- Adjust the rear wheel motor supports equally in one of the five settings up or down 0.375" each in a 1.5" total range.

Adjust the front caster arms at the support brackets equally in one of the seven settings up or down 0.25" each through a 1.5" total range.

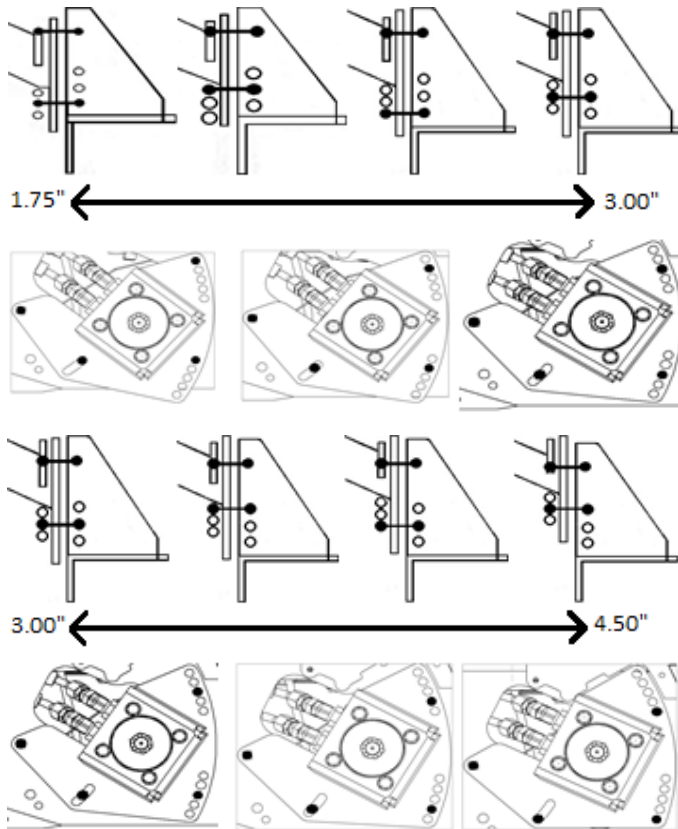

Using the maximums and minimums of these two methods gives you a total range of 2.75" from 1.75" to 4.5" in eleven distinct settings. The factory setting is 3" when measured to a hard floor surface at the front of the deck.

Cut Setting Recommendations

Correct cut height is critical to healthy turf. Cutting off more than 1/3rd of the blade stresses the turf. In general, the turf will be healthy when cut longer. When cut taller, the turf develops deeper roots, is more drought resistant, more disease resistant, and suppresses weeds. Cut quality is improved when cut heights are maintained as listed below:

Recommended Mowing Heights

- Tall Fescue: 1 1/2" – 3"
- Kentucky Bluegrass: 1 1/2" – 2 1/2"
- Bahia Grass: 2" – 3"
- Bermuda Grass: 1/2"-1"
- St. Augustine Grass: 1" – 3"
- Zoysia Grass: 1/2" – 1"

Clean under the deck regularly. Grass build up will cause the airflow to be interrupted and result in poor cut quality. Blades that are worn and have rounded tips will not cut well.

Troubleshooting Cut Quality

Problem	Description		Possible Cause	Solution
Streaking	When strips of uncut grass are left behind		Blades not sharp	Sharpen blades
			Blades worn down too far	Replace blades
			Engine RPM too low	Mow at full throttle
			Ground Speed too fast	Slow down
			Deck clogged with grass	Clean deck
Stepped Cutting	Sharp ridges left in the lawn surface		Deck not leveled correctly	Level the deck
			Tires not properly installed/inflated	Check and inflate tires
			Blades are damaged	Replace blades
			Deck shell is damaged	Repair or replace deck
			Spindle is bent or loose	Repair or replace spindle
Scalping	Brown areas when deck is close to/hitting the ground		Blades are installed incorrectly	Reinstall the blades correctly
			Lawn is uneven or bumpy	Roll or level the lawn
			Cut height is too low	Raise cutting height
			Deck is not leveled correctly	Level the deck
Stringers	Sparse patches of uncut grass left behind mower		Tire pressure is uneven	Check and inflate tires
			Blades are dull or nicked	Sharpen blades
			Blades worn down too far	Replace blades
			Engine RPM too low	Mow at full throttle
			Ground speed too fast	Slow down
			Deck clogged with grass	Clean deck

Belt Adjustment/Replacement

The pump drive belt and blade drive belt are self-adjusting, and require no adjustment, just replacement.

Replacing the Cutter Deck Belt

1. Stop the engine, remove the key and wait for all moving parts to stop.
2. Remove the deck cover.
3. Remove the belt by using a ½" ratchet and extension to relieve the belt tension.
4. Reinstall in reverse order. Figure shows belt routing and spring compression direction.

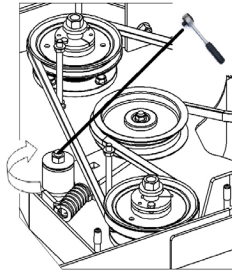

Replacing the Drive Belt

1. Stop the engine, remove the key and wait for all moving parts to stop.
2. Remove the deck cover and remove the blade belt. (Refer to replacing cutter deck belt section)
3. Raise and secure mower
4. Remove the belt by using a ½" ratchet and extension to relieve the belt tension.

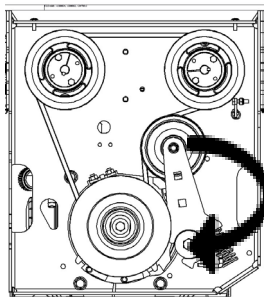

Hydraulic System

If air is entrained in the system, loss of power, excessive heat, and damage to the hydraulic pumps may occur. The cause of air in the system can be from a leaking hose pulling in air or after replacing a major component.

Bleeding Air from the Hydraulic System

If air is entrained in the system, loss of power, excessive heat, and damage to the hydraulic pumps may occur. The cause of air in the system can be from a leaking hose pulling in air or after replacing a major component.

1. Fill the reservoir.
2. Lift the machine so that the rear wheels are off the ground. Be careful to support the machine so that it will not fall or tip while the system is bled of air.

3. With the bypass valves open and the engine running, slowly move the control levers back and forth five or six times.
4. Now close the bypass valves and with the engine running, slowly move the control levers back and forth five or six times.
5. It may be necessary to repeat the above steps until all the air is purged and the rear wheels are turning at normal speed.
6. After purging is complete, adjust the oil level in the reservoir if necessary.

Checking oil

1. Ensure mower is on a level surface.
2. Lift hinged pad to access the sight-glass
3. Oil should be at the center of the sight-glass.



Filling oil

1. Lift hinged pad and remove vent cap.
2. Use a funnel to fill tank

Fuel Evaporation System

All Wright Stander need to have this mandatory feature.

- Do not alter or remove.
- Do not fill past the "Max Fill Level" line.
- Over-filling could result in clogging the roll-over vent and/or contaminating the purge canister.
- The vapor canister is located under the dash.
- Inspect and clean dust filter every 500hrs or annually.

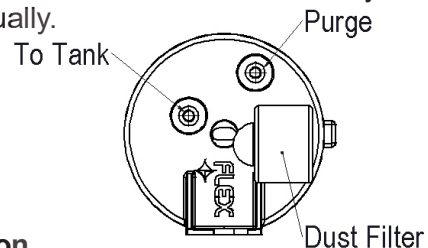

Lubrication

The Wright Stander is made with sealed bearings, oil based bushings and with limited grease fittings therefore only the front caster pivots need to be greased. (See maintenance chart for service intervals) Use No. 2 general purpose lithium base or molybdenum base grease.

1. Set parking brake, stop the engine and remove the key.
2. Clean grease fittings with a rag.
3. Connect grease gun to fitting and pump until grease begins to ooze out from the bearings.
4. Wipe off excess grease.

- Do not use spray lube of any kind on choke and/or throttle cables.

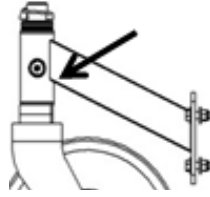

Spindle/Drive Pulley R&R

- Remove 2, 1/4" bolts from split hub and install in threaded holes in hub. (A)
- Slowly tighten each bolt, alternating as you tighten bolts against the pulley.
- The hub will separate from the pulley.
- Replace grade 8 bolts and install in reverse order using the assembly holes to tighten hub onto pulley and spindle shaft. (B)

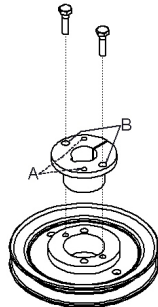

Cutting Blades

In order to maintain the best cut, it is important that the blades are well sharpened and not damaged. Bent or cracked blades or blades with large nicks need to be replaced. Blades must be balanced after sharpening. To change the blades:

- Stop engine, remove the key and wait for all moving parts to stop.
- Engage the parking brake
- Lift front of mower and secure in the raised position with jack stands.
- Remove the blade nut by turning counterclockwise.
- Install new or re-sharpened blade. (Ensure the blade spacers are reinstalled with the same qty and location)
- Torque blade bolt to 70-80 ft./lbs. / 95-108 N

Battery Service

⚠ WARNING

CALIFORNIA Proposition 65 Warning.

Battery posts, terminals, and related accessories contain lead and lead compounds, chemicals known by the state of California to cause cancer and reproductive harm. Wash hands after handling.

The battery is 12 volts and is a maintenance free battery. Charge the battery only if it will not start the machine properly. Remove the battery from the machine before charging. Follow the instructions of the battery charger for proper and safe charging of the battery. To access the battery, first, park the machine safely. Remove the retainer bolt and remove battery cover. Follow all warnings and cautions on the battery label and issued by the battery manufacturer.

Loading/Unloading

Use extreme caution when loading and unloading units on/off trailers or trucks. One full width ramp that extends beyond the rear tires is recommended rather than individual ramps for each side of the unit. The ramp should be long enough so that the angle between the ramp and the trailer or truck does not exceed 15 degrees. A steeper angle may cause the mower deck components to get caught as the unit moves from ramp to trailer or truck. Always put the deck in the transport (up & locked) position when loading or unloading. Never attempt to turn the mower around on the ramp. Avoid sudden acceleration when driving up a ramp and sudden deceleration when backing down a ramp.

Transportation

Use a heavy duty trailer or truck to transport the Stander. Lock brake and block wheels. Turn fuel valve to the "Off" position. Securely fasten the unit to the trailer or truck with straps, chains, cable or ropes. Secure the front by either strapping each caster arm or strap over both caster arms. The rear can be secured using the holes provided.

Cleaning the Machine

The underside of the mower deck should be checked and cleaned twice daily and more often if the grass being mowed is lush or wet. The entire mower should be cleaned daily at the end of the work day. Cleaning should be done with a leaf blower or low-pressure compressed air. Wash with water only when necessary and do not use a pressure washer or nozzle as the water can enter bearings and electrical connections causing an electrical short, rust and corrosion. When washing with water, avoid spraying near the hydro cap and do so when the unit has cooled down. Washing a hot machine can cause various unseen system damage. If water is used for cleaning, immediately dry it with a leaf blower or low-pressure compressed air and run with blades engaged for approximately 10 minutes. Once the wash is complete, always lubricate and grease all applicable areas.

Engine Manual / Maintenance

It is very important that all users of this machine read and understand the engine manufacturer's Owner's Manual. This manual contains; safety awareness, emissions, oil change intervals, cleanout intervals, maintenance and warranty information that is critical for the care and safe operation of your engine.

Maintenance Interval Chart

Note: this maintenance chart lists the basic engine items. See the specific engine manufacturer's manual for detailed maintenance items and warranty conditions.

Daily Visual

- Check and adjust engine oil. Do not screw in the dipstick when reading the oil level.
- Check intake air filter and replace as necessary
- Check and clean engine fan intake screen
- Check machine for debris and blow off as necessary
- Check blades for condition and sharpness
- Check deck and clean out as necessary
- Check for loose hardware, controls, and components
- Check for signs of oil or fuel leaks
- Check tires for loss of pressure and wear
- Check for labels and safety equipment

After 8hrs

- Replace engine oil and filter (varies by engine manufacturer)

Every 100hrs

- Clean engine cooling fins
- Replace engine oil and filter (Kawasaki only: replace filter every 200 hrs)

Every 300hrs

- Check and adjust valves

Every 500hrs or Annually/Offseason

- Replace hydro oil in tank and filter
- Check for idler, belt and spindle wear
- Check caster pivots
- Check caster wheel bearings
- Check fuel hose, tank, and grommets
- Check wiring and electrical components are in good condition and properly secured

The service intervals indicated are to be used as a guide. Service should be performed more frequently as necessary by operating conditions.

Maintenance Record

7 WRIGHT MANUFACTURING, INC. POWER EQUIPMENT LIMITED WARRANTY

SUPERSEDES ALL PREVIOUS WARRANTIES. EFFECTIVE FOR UNITS RETAILED ON OR AFTER 1/1/2019

Limited Warranty

Wright Manufacturing, Inc. (hereinafter: WMI) warrants to the original retail purchaser (Owner) and legitimate successors that any new WMI power equipment unit (Mower) originally accompanied by this warranty with a retail sales date on or after the effective date above will be free from manufacturing defects in materials or workmanship subject to the limitations and exclusions defined below. Any part of the Mower found, in the reasonable judgment of WMI, to be defective in materials or workmanship, will be repaired or replaced by an Authorized WMI Service Dealer without charge for parts and (except as excluded below) labor.

This Warranty is transferrable with its remaining conditions to legitimate successor Owners to the original retail purchaser/owner. Dealer demo units with less than fifty hours when first retailed shall also be covered by this limited warranty. Proofs of Purchase will be required by the Authorized WMI Service Dealer to substantiate any warranty claims.

All WMI warranty work must be performed by an Authorized WMI Service Dealer and the Mower must be delivered to the dealer prior to the expiration of the warranty period. This Warranty is limited to the following specified periods from the date of the original retail purchase for defects in materials or workmanship and will commence upon the date of original retail purchase.

This warranty shall apply only if the warranty registration form has been completed on-line by an Authorized WMI Service Dealer and reflects the actual date of original retail purchase.

This warranty includes only the cost of parts and labor (when applicable). This warranty applies only to the replacement of defective or otherwise warrantable WMI OEM parts being replaced with WMI OEM parts.

Wright Stander B (WSB) Only:

- All parts and components (except as noted below)
- 1 year/Unlimited Hours Commercial
- 3 years/500 hours Non-Commercial*
- Belts – 90 days
- Battery – 90 days
- Engine – warranty covered by engine manufacturer and handled through the respective Authorized engine dealers

All Other WMI Power Equipment:

- All parts and components (except as noted Below)
- 2 years/Unlimited Hours Commercial
- 5 years/500 hours Non-Commercial*
- Belts – 90 days
- Battery – 90 days
- Engine – warranty covered by engine manufacturer and handled through the respective Authorized engine dealers

Exclusions

- Any damage or deterioration due to normal use, wear and tear or exposure
- All filters, engine oil, hydraulic oil, tires and tubes
- Bent, fractured or broken parts occurring through impact or hard use
- Clutch: linings, anti-rotation failure or other failure due to improper replacement installation
- Cost of regular maintenance service, parts or adjustments
- Worn bearings
- Worn bushings, cotters, clips, pins and retainers
- Grease/zerk fittings
- Paint, paint fading, cosmetic imperfections and steel surface imperfections
- Fabric, cushion and rubber grip wear or damage
- Cutting blades, light bulbs, fuses
- Any damage due to previous improperly performed or unauthorized repairs
- Fire or water damage
- Abrasion, rust or corrosion wear or damage

Repair Parts Replaced During Original Warranty

All Repair parts (excluding wear or otherwise excluded items) installed during the original power equipment warranty period are warranted until the end of the respective original period according to the categories above except in the case that the respective original warranty period expires in less than ninety (90) days after the installation of the part(s). If this happens then the parts are warranted for a total of ninety (90) days from the time of their installation.

Rental Use

The above warranty periods are limited to a maximum of ninety (90) days for power equipment that is used for rental purposes.

Other conditions

The Mower, including any defective part, must be returned to an Authorized WMI Service Dealer within the warranty period. The expense of lost production time and delivering the Mower to the Authorized WMI Service Dealer for warranty work and the expense of returning it to the Owner after repair will be paid for by the Owner. WMI's responsibility is limited to making the required repairs and no claim of breach of warranty shall be cause for cancellation or rescission of the contract of sale of any WMI power equipment.

This Warranty does not cover any WMI power equipment that has been subject to misuse, neglect, negligence, burning in any fire, flooded by water, damaged in an accident, or that has been operated or maintained in any way contrary to the operating and maintenance instructions as specified in the Owner's Manual. The Warranty does not apply to any damage to the Mower that is the result of improper maintenance; or to any WMI power equipment or parts that have not been assembled or installed as specified in the Owner's Manual. The Warranty does not cover WMI power equipment that has been altered or modified changing performance or durability. In addition, the Warranty does not extend to repairs made necessary by normal wear, or by the use of parts or accessories which, in the reasonable judgment of WMI, are either incompatible with the Mower or adversely affect its operation, performance or durability.

WMI reserves the right to change or improve the design of any WMI power equipment without assuming any obligation to modify any WMI power equipment previously manufactured.

All other implied warranties are limited in duration to the applicable one (1) year or two (2) year warranty period or ninety (90) days for units used for rental purposes. Accordingly, any such implied warranties including merchantability, fitness for a particular purpose, or otherwise, are disclaimed in their entirety after the expiration for the appropriate one (1) year, two (2) year, or ninety (90) day warranty period.

WMI's obligation under this Warranty is strictly limited to the repair or replacement of defective parts and WMI does not assume, or authorize anyone to assume for them, any other obligation. Some states do not allow limitations on how long an implied warranty lasts, so the above limitation may not apply.

WMI assumes no responsibility for incidental, consequential or other damages including, but not limited to, expense for gasoline, expense of delivering the Mower to an Authorized WMI Service Dealer and expense of returning it to the Owner, damage by fire, mechanic's travel time, telephone charges, rental of a like product during the time warranty repairs are being performed, travel, loss or damage to personal property, loss of revenue, loss of use of the Mower, loss of time or inconvenience. Some states do not allow the exclusion or limitation of incidental or consequential damages, so the above limitation or exclusion may not apply.

This Warranty gives you specific legal rights, and you may also have other rights which vary from state to state.

This Warranty applies to all WMI power equipment retailed and located in the United States of America and Canada.

*Non-Commercial: Mower is used only on one home lot. Use at multiple locations is considered commercial use and the commercial warranty would apply.

For the location of the Authorized WMI Service Dealer nearest you or other information, such as Parts Lists and Owner's Manuals, please visit our website at: www.wrightmfg.com

8 FEDERAL AND CALIFORNIA EMISSION CONTROL WARRANTY STATEMENT

YOUR WARRANTY RIGHTS AND OBLIGATIONS

The United States Environmental Protection Agency, California Air Resources Board and Wright Manufacturing, Inc. are pleased to explain the evaporative emissions control system warranty on your 2019 – 2020 commercial equipment. In the United States and California, new equipment that use small off-road engines must be designed, built, and equipped to meet the State's stringent anti-smog standards. Wright Manufacturing, Inc. must warrant the emissions control system on your commercial equipment for the periods of time listed below provided there has been no abuse, neglect or improper maintenance of your small off-road engine or equipment leading to the failure of the emissions control system.

Your emissions control system may include parts such as the carburetor or fuel-injection system, the ignition system, catalytic converter, fuel tanks, fuel lines (for liquid fuel and fuel vapors), fuel caps, valves, canisters, filters, clamps and other associated components. Also included may be hoses, belts, connectors, and other emission-related assemblies.

Where a warrantable condition exists, Wright Manufacturing, Inc. will repair your commercial equipment at no cost to you including diagnosis, parts and labor.

MANUFACTURER'S WARRANTY COVERAGE:

The evaporative emissions control system on your commercial equipment is warranted for two years. If any emissions-related part on your commercial equipment is defective, the part will be repaired or replaced by Wright Manufacturing, Inc.

OWNER'S WARRANTY RESPONSIBILITIES:

- As the commercial equipment owner, you are responsible for the performance of the required maintenance listed in your owner's manual. Wright Manufacturing, Inc. recommends that you retain all receipts covering maintenance on your commercial equipment, but Wright Manufacturing, Inc. cannot deny warranty coverage solely for the lack of receipts or for your failure to ensure the performance of all scheduled maintenance.
- As the commercial equipment owner, you should however be aware that Wright Manufacturing, Inc. may deny you warranty coverage if your commercial equipment or a part has failed due to abuse, neglect, or improper maintenance or unapproved modifications.
- You are responsible for presenting your commercial equipment to a Wright Manufacturing, Inc. distribution center or service center as soon as the problem exists. The warranty repairs shall be completed in a reasonable amount of time, not to exceed 30 days.

If you have any questions regarding your warranty rights and responsibilities, you should contact Wright Manufacturing, Inc. at (301) 360-9810.

WARRANTED PARTS:

The following emission warranty parts listed below are covered:

- | | |
|--|--------------------------------------|
| (1) Fuel Tank | (10) Vacuum Control Diaphragms |
| (2) Fuel Cap | (11) Control Cables |
| (3) Fuel Lines (for liquid fuel and fuel vapors) | (12) Control Linkages |
| (4) Fuel Line Fittings | (13) Purge Valves |
| (5) Clamps | (14) Gaskets |
| (6) Pressure Relief Valves | (15) Liquid/Vapor Separator |
| (7) Control Valves | (16) Carbon Canister |
| (8) Control Solenoids | (17) Canister Mounting Brackets |
| (9) Electronic Controls | (18) Carburetor Purge Port Connector |



4600 Wedgewood Blvd Ste X

Frederick MD 21703-7167

www.wrightmfg.com